Rally Documentation

0.9.0

lyremelody

2018 01 22

1		1
2	Rally 0.9.0	3
3		5
4		7
4.1	7
4.2	9
4.3	11
4.4	: Races	14
4.5	???: Tournaments	17
4.6	19
4.7	Define Custom Workloads: Tracks	25
4.8	Developing Rally	42
4.9	Command Line Reference	43
4.10	Offline Usage	53
4.11	Track Reference	54
4.12	Configure Elasticsearch: Cars	78
4.13	Using Elasticsearch Plugins	81
4.14	Telemetry Devices	87
4.15	Rally Daemon	89
4.16	Pipelines	90
4.17	Metrics	92
4.18	95
4.19	Migration Guide	98
4.20	Frequently Asked Questions (FAQ)	103
4.21	104
4.22	Community Resources	105
5	License	107

CHAPTER 1

esrally Rally

lyremelody AT 163 dot com

ElasticsearchRally

- Elasticsearch
- Elasticsearch
-
- Finding performance problems by attaching so-called telemetry devices
-

Rally

RallyElasticsearch 1.x Elasticsearch 5.0

CHAPTER 3

Use our [Discuss forum](#) to provide feedback or ask questions about Rally. Please see our [contribution guide](#) on guidelines for contributors.

```

-----
|           Metric |           Task |           Value |           Unit |
|-----:|-----:|-----:|-----:|
|       Indexing time |           |       28.0997 |           min |
|         Merge time |           |        6.84378 |           min |
|         Refresh time |           |        3.06045 |           min |
|           Flush time |           |       0.106517 |           min |
| Merge throttle time |           |        1.28193 |           min |
|   Median CPU usage |           |         471.6 |           % |
| Total Young Gen GC |           |         16.237 |           s |
| Total Old Gen GC |           |          1.796 |           s |
|           Index size |           |        2.60124 |           GB |
|       Totally written |           |        11.8144 |           GB |
| Heap used for segments |           |        14.7326 |           MB |
| Heap used for doc values |           |        0.115917 |           MB |
|   Heap used for terms |           |        13.3203 |           MB |
|   Heap used for norms |           |       0.0734253 |           MB |
|   Heap used for points |           |         0.5793 |           MB |
| Heap used for stored fields |           |        0.643608 |           MB |
|       Segment count |           |           97 |           |
|   Min Throughput |   index-append |       31925.2 |   docs/s |
|   Median Throughput |   index-append |       39137.5 |   docs/s |
|   Max Throughput |   index-append |       39633.6 |   docs/s |
| 50.0th percentile latency |   index-append |        872.513 |           ms |
| 90.0th percentile latency |   index-append |       1457.13 |           ms |
| 99.0th percentile latency |   index-append |       1874.89 |           ms |
| 100th percentile latency |   index-append |       2711.71 |           ms |
| 50.0th percentile service time |   index-append |       872.513 |           ms |
| 90.0th percentile service time |   index-append |       1457.13 |           ms |
| 99.0th percentile service time |   index-append |       1874.89 |           ms |
| 100th percentile service time |   index-append |       2711.71 |           ms |
|           ... |           ... |           ... |           ... |
|           ... |           ... |           ... |           ... |
|   Min Throughput |   painless_dynamic |       2.53292 |   ops/s |
|   Median Throughput |   painless_dynamic |       2.53813 |   ops/s |
|   Max Throughput |   painless_dynamic |       2.54401 |   ops/s |
| 50.0th percentile latency |   painless_dynamic |       172208 |           ms |
| 90.0th percentile latency |   painless_dynamic |       310401 |           ms |
| 99.0th percentile latency |   painless_dynamic |       341341 |           ms |
| 99.9th percentile latency |   painless_dynamic |       344404 |           ms |
| 100th percentile latency |   painless_dynamic |       344754 |           ms |
| 50.0th percentile service time |   painless_dynamic |        393.02 |           ms |
| 90.0th percentile service time |   painless_dynamic |       407.579 |           ms |
| 99.0th percentile service time |   painless_dynamic |       430.806 |           ms |
| 99.9th percentile service time |   painless_dynamic |       457.352 |           ms |
| 100th percentile service time |   painless_dynamic |       459.474 |           ms |
|-----:|-----:|-----:|-----:|
|[INFO] SUCCESS (took 2634 seconds)
-----

```

4.1.4

Rally
 esrally --help

4.2

Rally

4.2.1

Rally Windows MacOS Linux Rally

Python

- Python 3.4 `python3 PATH python3 --version`
- Python3 Python3
- pip3 `PATH pip3 --version`

Debian / Ubuntu

```
sudo apt-get install gcc python3-pip python3-dev
```

RHEL 6/ CentOS 6

CentOS release 6.9 (Final).

```
: EPEL
```

```
sudo yum install -y gcc python34.x86_64 python34-devel.x86_64 python34-setuptools.
↪noarch
# installs pip as it is not available as an OS package
sudo python3 /usr/lib/python3.4/site-packages/easy_install.py pip
```

RHEL 7 / CentOS 7

```
: EPEL
```

CentOS Linux release 7.4.1708 (Core).

```
sudo yum install -y gcc python34.x86_64 python34-devel.x86_64 python34-pip.noarch
```

Amazon Linux

```
sudo yum install -y gcc python35-pip.noarch python35-devel.x86_64
```

MacOS

Homebrew:

```
brew install python3
```

git

```
git 1.9 git --version
```

Debian / Ubuntu

```
sudo apt-get install git
```

Red Hat / CentOS / Amazon Linux

```
sudo yum install git
```

```
: RHEL Red Hat Software Collections git
```

MacOS

```
git MacOS
```

JDK

```
Elasticsearch JDK Rally JDK
```

```
Oracle JDKOpenJDK JDK
```

```
: RallyElasticsearch ( Rally ) Rally
```

4.2.2 Rally

```
pip Rally: pip3 install esrally
```

```
: sudo
```

```
psutil psutil CPU Python
```

4.2.3 Non-sudo

```
sudo
```

```
1. Rally --user python3 setup.py develop --user
```

```
2. Python documentation on the variable site.USER_BASE esrally Linux ~/.local/bin  
~/.local/bin PATH ~/.local/bin/esrally esrally
```

4.2.4 VirtualEnv

```
VirtualenvRallysudo
```

```
1. virtualenv --python=python3 virtualenv
```

```
2. source /path/to/virtualenv/dir/bin/activate virtualenv
```

```
3. pip install esrally Rally
Rally2RallyShell deactivate
```

4.2.5 Kubernetes Job

this [Helm Chart](#) Rally Kubernetes Job

4.2.6 Docker

Rally docker

4.2.7

Rally

- 1.
- 2.
3. tar -xzf esrally-dist-*.tar.gz
4. sudo ./esrally-dist-*/install.sh

4.2.8

Rally esrally configure

4.3

RallyRally esrally

Rally esrally configure

4.3.1

Rally Rally esrally configure --advanced-config

Rally Elasticsearch Rally Elasticsearch Elasticsearch 5.0 Elasticsearh 5.0 Maven GradleRally GradleElasticsearch 5.0

Elasticsearch Gradle

esrally:

```
dm@io:~ $ esrally
```

```

  _____
 /  _  \  _  \  /  /  \  _  \
/  /  \ /  /  \ /  /  \ /  /
/  _  \ /  /  \ /  /  \ /  /
/  /  \ /  /  \ /  /  \ /  /
/  /  \ /  /  \ /  /  \ /  /
  _____
```

More info about Rally:

- * Type `esrally --help`
- * Read the documentation at <https://esrally.readthedocs.io/en/latest/>
- * Ask a question on the forum at <https://discuss.elastic.co/c/elasticsearch/rally>

4.3.2

(metrics) Elasticsearch `esrally configure --advanced-config`

Rally (metrics) Elasticsearch :

- ElasticsearchRallyElasticsearch [Elastic Cloud](#)
- Kibana [Elastic Cloud](#)

Elasticsearch 5.0Rally>Elasticsearch

: Rally 39200-39300 (HTTP) 39300-39400 (transport)

Kibana RallyKibana

Rally

- **(data directory):** Rally GB
- **Elasticsearch** : `ElasticsearchElasticsearch>Rally gradle clean gradle :distribution:tar:assemble`
- **JDK 8** : RallyJDK 8homeJDK Java 8 Rally Java 8 Java 9
- **Metrics store type:** `in-memory elasticsearch in-memory elasticsearch Elasticsearch (metrics)`
- **Metrics store settings** (`metrics store type elasticsearch`) `Elasticsearch Rally Elasticsearch`
- **Name for this benchmark environment** (`metrics store type elasticsearch`)`()`
- `RallyElasticsearch ~/.rally/benchmarks/races`

4.3.3

Rally downloads all necessary data automatically for you:

- Elasticsearch distributions from [elastic.co](https://www.elastic.co) if you specify `--distribution-version=SOME_VERSION_NUMBER`

- Elasticsearch source code from Github if you specify a revision number e.g. `--revision=952097b`
- Track meta-data from Github
- Track data from an S3 bucket

Hence, it needs to connect via http(s) to the outside world. If you are behind a corporate proxy you need to configure Rally and git. As many other Unix programs, Rally relies that the HTTP proxy URL is available in the environment variable `http_proxy` (note that this is in lower-case). Hence, you should add this line to your shell profile, e.g. `~/.bash_profile`:

```
export http_proxy=http://proxy.acme.org:8888/
```

Afterwards, source the shell profile with `source ~/.bash_profile` and verify that the proxy URL is correctly set with `echo $http_proxy`.

Finally, you can set up git:

```
git config --global http.proxy $http_proxy
```

For details, please refer to the [Git config documentation](#).

Please verify that the proxy setup for git works correctly by cloning any repository, e.g. the `rally-tracks` repository:

```
git clone https://github.com/elastic/rally-tracks.git
```

If the configuration is correct, git will clone this repository. You can delete the folder `rally-tracks` after this verification step.

To verify that Rally will connect via the proxy server you can check the log file. If the proxy server is configured successfully, Rally will log the following line on startup:

```
Rally connects via proxy URL [http://proxy.acme.org:3128/] to the Internet (picked up ↪  
↪from the environment variable [http_proxy]).
```

: Rally will use this proxy server only for downloading benchmark-related data. It will not use this proxy for the actual benchmark.

4.4 : Races

```
, "race""track""challenge"()
```

4.4.1

```
Rally"race"( tracks )
```

4.4.2 Track

tracks:

```
esrally list tracks
```

:

Name	Description	Documents	
↳ Compressed Size	Uncompressed Size	Default Challenge	↳ All Challenges
↳ -----	-----	-----	-----
geonames	POIs from Geonames	11396505	252.4 MB ↳
↳ 3.3 GB	append-no-conflicts	append-no-conflicts, appe...	
geopoint	Point coordinates from PlanetOSM	60844404	481.9 MB ↳
↳ 2.3 GB	append-no-conflicts	append-no-conflicts, appe...	
http_logs	HTTP server log data	247249096	1.2 GB ↳
↳ 31.1 GB	append-no-conflicts	append-no-conflicts, appe...	
nested	StackOverflow Q&A stored as nested docs	11203029	663.1 MB ↳
↳ 3.4 GB	nested-search-challenge	nested-search-challenge, ...	
noaa	Global daily weather measurements from NOAA	33659481	947.3 MB ↳
↳ 9.0 GB	append-no-conflicts	append-no-conflicts, appe...	
nyc_taxis	Taxi rides in New York in 2015	165346692	4.5 GB ↳
↳ 74.3 GB	append-no-conflicts	append-no-conflicts, appe...	
percolator	Percolator benchmark based on AOL queries	2000000	102.7 kB ↳
↳ 104.9 MB	append-no-conflicts	append-no-conflicts, appe...	
pmc	Full text benchmark with academic papers from PMC	574199	5.5 GB ↳
↳ 21.7 GB	append-no-conflicts	append-no-conflicts, appe...	

track track challenges

4.4.3

: root Rally Elasticsearch root

track challenge :

```
esrally --distribution-version=6.0.0 --track=geopoint --challenge=append-fast-with-
↳ conflicts
```

Rally track Rally:

```
dm@io:~ $ esrally --distribution-version=6.0.0 --track=geopoint --challenge=append-
↳ fast-with-conflicts
```

```

  _____
 /  _  \  _  /  /  /  /  /
/  /  \  /  \  /  /  /  /
/  _  \  /  \  /  /  /  /
/_/  |_\  \  /  \  \  \  /
      /  _  \

```

```
[INFO] Racing on track [geopoint], challenge [append-fast-with-conflicts] and car [
↳ 'defaults'] with version [6.0.0].
[INFO] Downloading Elasticsearch 6.0.0 ... [OK]
[INFO] Rally will delete the benchmark candidate after the benchmark
[INFO] Downloading data from [http://benchmarks.elasticsearch.org.s3.amazonaws.com/
↳ corpora/geopoint/documents.json.bz2] (482 MB) to [/Users/dm/.rally/benchmarks/data/
↳ geopoint/documents.json.bz2] ... [OK]
[INFO] Decompressing track data from [/Users/dm/.rally/benchmarks/data/geopoint/
↳ documents.json.bz2] to [/Users/dm/.rally/benchmarks/data/geopoint/documents.json]
↳ (resulting size: 2.28 GB) ... [OK]
```

```
[INFO] Preparing file offset table for [/Users/dm/.rally/benchmarks/data/geopoint/
↳documents.json] ... [OK]
Running index-update [ 0%
↳done]
```

Rally :

Metric	Task	Value	Unit
Indexing time		124.712	min
Merge time		21.8604	min
Refresh time		4.49527	min
Merge throttle time		0.120433	min
Median CPU usage		546.5	%
Total Young Gen GC		72.078	s
Total Old Gen GC		3.426	s
Index size		2.26661	GB
Totally written		30.083	GB
Heap used for segments		10.7148	MB
Heap used for doc values		0.0135536	MB
Heap used for terms		9.22965	MB
Heap used for points		0.78789	MB
Heap used for stored fields		0.683708	MB
Segment count		115	
Min Throughput	index-update	59210.4	docs/s
Median Throughput	index-update	65276.2	docs/s
Max Throughput	index-update	76516.6	docs/s
50.0th percentile latency	index-update	556.269	ms
90.0th percentile latency	index-update	852.779	ms
99.0th percentile latency	index-update	1854.31	ms
99.9th percentile latency	index-update	2972.96	ms
99.99th percentile latency	index-update	4106.91	ms
100th percentile latency	index-update	4542.84	ms
50.0th percentile service time	index-update	556.269	ms
90.0th percentile service time	index-update	852.779	ms
99.0th percentile service time	index-update	1854.31	ms
99.9th percentile service time	index-update	2972.96	ms
99.99th percentile service time	index-update	4106.91	ms
100th percentile service time	index-update	4542.84	ms
Min Throughput	force-merge	0.221067	ops/s
Median Throughput	force-merge	0.221067	ops/s
Max Throughput	force-merge	0.221067	ops/s
100th percentile latency	force-merge	4523.52	ms
100th percentile service time	force-merge	4523.52	ms

[INFO] SUCCESS (took 1624 seconds)

```
: --report-file=/path/to/your/report.md --report-format=csv CSV
```

Rally

- Elasticsearch 6.0.0
- geopoint track

-
-

Rally `geopoint track` Rally *Elasticsearch* Kibana *Elasticsearch*

4.5 Tournaments

????????????????L???

?????????????????????:

```
esrally --track=pmc --revision=latest --user-tag="intention:baseline_github_1234"
```

????????? Elasticsearch ??????????λ????????????????????? --user-tag ??????????????4?????????

????????g????????????????????????????????????????K????????????????????????? Rally ?????g????(????? Rally
 ?δ?L?Î????????????????Î??)????????????α?? current:

```
esrally --track=pmc --revision=current --user-tag="intention:reduce_alloc_1234"
```

????????????????????????????????????? Rally ?????k????????????L????????????????? esrally list races
 ?????????L?????:

```
dm@io:~ $ esrally list races
```

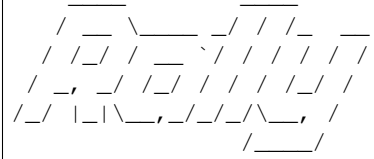

Recent races:

Race Timestamp	Track	Track Parameters	Challenge	Car	User Tag
20160518T122341Z	pmc		append-no-conflicts	defaults	↳
↳intention:reduce_alloc_1234					
20160518T112057Z	pmc		append-no-conflicts	defaults	↳
↳intention:baseline_github_1234					
20160518T101957Z	pmc		append-no-conflicts	defaults	

?????????User Tag????????????????????? --user-tag ?????g????????????????λ????????????β?????:

```
dm@io:~ $ esrally compare --baseline=20160518T112057Z --contender=20160518T122341Z
```

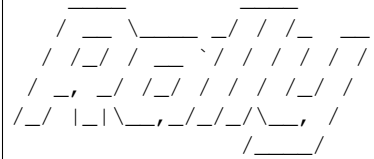

Comparing baseline
 Race timestamp: 2016-05-18 11:20:57
 Challenge: append-no-conflicts
 Car: defaults

with contender

Race timestamp: 2016-05-18 12:23:41

Challenge: append-no-conflicts

Car: defaults

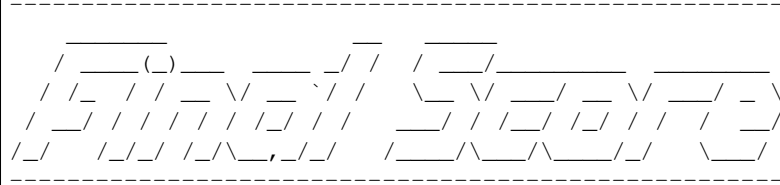

Diff	Metric	Baseline	Contender	
↔	Min Indexing Throughput [docs/s]	19501	19118	-
↔383.00000	Median Indexing Throughput [docs/s]	20232	19927.5	-
↔304.45833	Max Indexing Throughput [docs/s]	21172	20849	-
↔323.00000	Indexing time [min]	55.7989	56.335	⬇
↔+0.53603	Merge time [min]	12.9766	13.3115	⬇
↔+0.33495	Refresh time [min]	5.20067	5.20097	⬇
↔+0.00030	Flush time [min]	0.0648667	0.0681833	⬇
↔+0.00332	Merge throttle time [min]	0.796417	0.879267	⬇
↔+0.08285	Query latency term (50.0 percentile) [ms]	2.10049	2.15421	⬇
↔+0.05372	Query latency term (90.0 percentile) [ms]	2.77537	2.84168	⬇
↔+0.06630	Query latency term (100.0 percentile) [ms]	4.52081	5.15368	⬇
↔+0.63287	Query latency country_agg (50.0 percentile) [ms]	112.049	110.385	-
↔1.66392	Query latency country_agg (90.0 percentile) [ms]	128.426	124.005	-
↔4.42138	Query latency country_agg (100.0 percentile) [ms]	155.989	133.797	-
↔22.19185	Query latency scroll (50.0 percentile) [ms]	16.1226	14.4974	-
↔1.62519	Query latency scroll (90.0 percentile) [ms]	17.2383	15.4079	-
↔1.83043	Query latency scroll (100.0 percentile) [ms]	18.8419	18.4241	-
↔0.41784	Query latency country_agg_cached (50.0 percentile) [ms]	1.70223	1.64502	-
↔0.05721	Query latency country_agg_cached (90.0 percentile) [ms]	2.34819	2.04318	-
↔0.30500	Query latency country_agg_cached (100.0 percentile) [ms]	3.42547	2.86814	-
↔0.55732	Query latency default (50.0 percentile) [ms]	5.89058	5.83409	-
↔0.05648				

↔0.06620	Query latency default (90.0 percentile) [ms]	6.71282	6.64662	-
↔0.28297	Query latency default (100.0 percentile) [ms]	7.65307	7.3701	-
↔+0.00506	Query latency phrase (50.0 percentile) [ms]	1.82687	1.83193	└
↔0.17428	Query latency phrase (90.0 percentile) [ms]	2.63714	2.46286	-
↔1.17525	Query latency phrase (100.0 percentile) [ms]	5.39892	4.22367	-
↔+11.12499	Median CPU usage (index) [%]	668.025	679.15	└
↔+18.64999	Median CPU usage (stats) [%]	143.75	162.4	└
↔+6.10000	Median CPU usage (search) [%]	223.1	229.2	└
↔+1.00900	Total Young Gen GC [s]	39.447	40.456	└
↔+0.59500	Total Old Gen GC [s]	7.108	7.703	└
↔0.00377	Index size [GB]	3.25475	3.25098	-
↔+0.47083	Totally written [GB]	17.8434	18.3143	└
↔0.16037	Heap used for segments [MB]	21.7504	21.5901	-
↔0.02531	Heap used for doc values [MB]	0.16436	0.13905	-
↔0.11345	Heap used for terms [MB]	20.0293	19.9159	-
↔0.01190	Heap used for norms [MB]	0.105469	0.0935669	-
↔0.00133	Heap used for points [MB]	0.773487	0.772155	-
↔0.00837	Heap used for points [MB]	0.677795	0.669426	-
↔15.00000	Segment count	136	121	-
↔+0.04969	Indices Stats(90.0 percentile) [ms]	3.16053	3.21023	└
↔1.35393	Indices Stats(99.0 percentile) [ms]	5.29526	3.94132	-
↔+1.37403	Indices Stats(100.0 percentile) [ms]	5.64971	7.02374	└
↔0.04360	Nodes Stats(90.0 percentile) [ms]	3.19611	3.15251	-
↔+0.42892	Nodes Stats(99.0 percentile) [ms]	4.44111	4.87003	└
↔+0.44450	Nodes Stats(100.0 percentile) [ms]	5.22527	5.66977	└

4.6

This section covers various tips and tricks when using Rally in a recipe-style fashion.

4.6.1 Benchmarking an existing cluster

: If you are just getting started with Rally and don't understand how it works, please do NOT run it against any production or production-like cluster. Besides, benchmarks should be executed in a dedicated environment anyway where no additional traffic skews results.

: We assume in this recipe, that Rally is already properly *configured*.

Consider the following configuration: You have an existing benchmarking cluster, that consists of three Elasticsearch nodes running on 10.5.5.10, 10.5.5.11, 10.5.5.12. You've setup the cluster yourself and want to benchmark it with Rally. Rally is installed on 10.5.5.5.

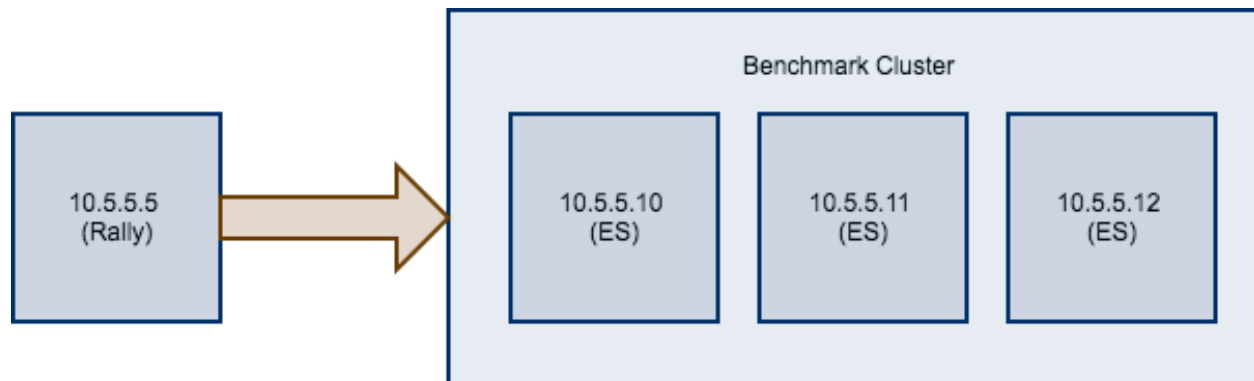

First of all, we need to decide on a track. So, we run `esrally list tracks`:

Name	Description	Documents
↳Compressed Size	Uncompressed Size	All Challenges
↳-----	-----	-----
↳ geonames	POIs from Geonames	11396505 252.4 MB
↳	3.3 GB append-no-conflicts	append-no-conflicts, appe...
↳ geopoint	Point coordinates from PlanetOSM	60844404 481.9 MB
↳	2.3 GB append-no-conflicts	append-no-conflicts, appe...
↳ http_logs	HTTP server log data	247249096 1.2 GB
↳	31.1 GB append-no-conflicts	append-no-conflicts, appe...
↳ nested	StackOverflow Q&A stored as nested docs	11203029 663.1 MB
↳	3.4 GB nested-search-challenge	nested-search-challenge, ...
↳ noaa	Global daily weather measurements from NOAA	33659481 947.3 MB
↳	9.0 GB append-no-conflicts	append-no-conflicts, appe...
↳ nyc_taxis	Taxi rides in New York in 2015	165346692 4.5 GB
↳	74.3 GB append-no-conflicts	append-no-conflicts, appe...
↳ percolator	Percolator benchmark based on AOL queries	2000000 102.7 kB
↳	104.9 MB append-no-conflicts	append-no-conflicts, appe...
↳ pmc	Full text benchmark with academic papers from PMC	574199 5.5 GB
↳	21.7 GB append-no-conflicts	append-no-conflicts, appe...

We're interested in a full text benchmark, so we'll choose to run `pmc`. If you have your own data that you want to use for benchmarks, then please *create your own track* instead; the metrics you'll gather which be representative and much more useful than some default track.

Next, we need to know which machines to target which is easy as we can see that from the diagram above.

Finally we need to check which *pipeline* to use. For this case, the `benchmark-only` pipeline is suitable as we don't want Rally to provision the cluster for us.

Now we can invoke Rally:

```
esrally --track=pmc --target-hosts=10.5.5.10:9200,10.5.5.11:9200,10.5.5.12:9200 --
↳ pipeline=benchmark-only
```

If you have **X-Pack Security** enabled, then you'll also need to specify another parameter to use https and to pass credentials:

```
esrally --track=pmc --target-hosts=10.5.5.10:9243,10.5.5.11:9243,10.5.5.12:9243 --
↳ pipeline=benchmark-only --client-options="use_ssl:true,verify_certs:true,basic_auth_
↳ user:'elastic',basic_auth_password:'changeme'"
```

4.6.2 Benchmarking a remote cluster

Contrary to the previous recipe, you want Rally to provision all cluster nodes.

We will use the following configuration for the example:

- You will start Rally on `10.5.5.5`. We will call this machine the “benchmark coordinator”.
- Your Elasticsearch cluster will consist of two nodes which run on `10.5.5.10` and `10.5.5.11`. We will call these machines the “benchmark candidate”s.

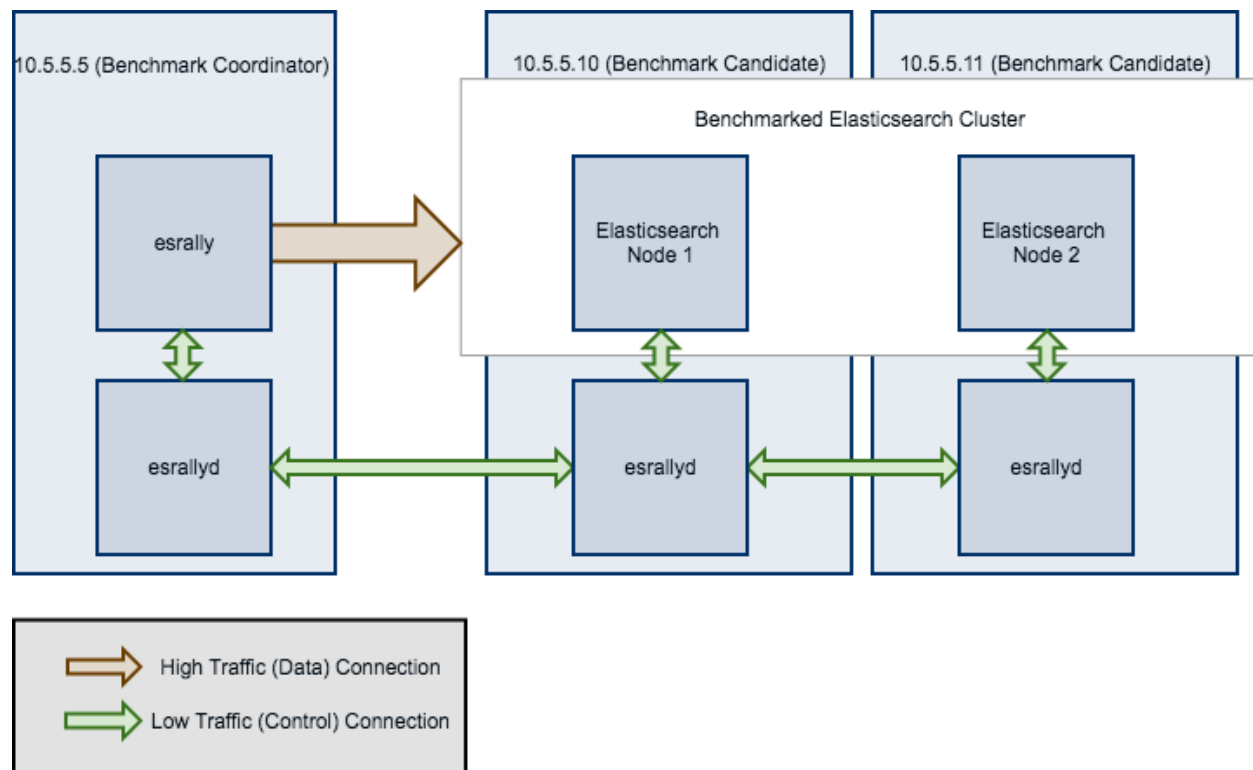

: All `esrallyd` nodes form a cluster that communicates via the “benchmark coordinator”. For aesthetic reasons we do not show a direct connection between the “benchmark coordinator” and all nodes.

To run a benchmark for this scenario follow these steps:

1. *Install* and *configure* Rally on all machines. Be sure that the same version is installed on all of them and fully *configured*.
2. Start the *Rally daemon* on each machine. The Rally daemon allows Rally to communicate with all remote machines. On the benchmark coordinator run `esrallyd start --node-ip=10.5.5.5 --coordinator-ip=10.5.5.5` and on the benchmark candidate machines run `esrallyd start --node-ip=10.5.5.10 --coordinator-ip=10.5.5.5` and `esrallyd start --node-ip=10.5.5.11 --coordinator-ip=10.5.5.5` respectively. The `--node-ip` parameter tells Rally the IP of the machine on which it is running. As some machines have more than one network interface, Rally will not attempt to auto-detect the machine IP. The `--coordinator-ip` parameter tells Rally the IP of the benchmark coordinator node.
3. Start the benchmark by invoking Rally as usual on the benchmark coordinator, for example: `esrally --distribution-version=5.0.0 --target-hosts=10.5.5.10:9200,10.5.5.11:9200`. Rally will derive from the `--target-hosts` parameter that it should provision the nodes `10.5.5.10` and `10.5.5.11`.
4. After the benchmark has finished you can stop the Rally daemon again. On the benchmark coordinator and on the benchmark candidates run `esrallyd stop`.

: Logs are managed per machine, so all relevant log files and also telemetry output is stored on the benchmark candidates but not on the benchmark coordinator.

Now you might ask yourself what the differences to benchmarks of existing clusters are. In general you should aim to give Rally as much control as possible as benchmark are easier reproducible and you get more metrics. The following table provides some guidance on when to choose which option:

Your requirement	Recommendation
You want to use Rally's telemetry devices	Use Rally daemon, as it can provision the remote node for you
You want to benchmark a source build of Elasticsearch	Use Rally daemon, as it can build Elasticsearch for you
You want to tweak the cluster configuration yourself	Use Rally daemon with a <i>custom configuration</i> or set up the cluster by yourself and use <code>--pipeline=benchmark-only</code>
You need to run a benchmark with plugins	Use Rally daemon if the <i>plugins</i> are supported or set up the cluster by yourself and use <code>--pipeline=benchmark-only</code>
You need to run a benchmark against multiple nodes	Use Rally daemon if all nodes can be configured identically. For more complex cases, set up the cluster by yourself and use <code>--pipeline=benchmark-only</code>

Rally daemon will be able to cover most of the cases described above in the future so there should be almost no case where you need to use the `benchmark-only` pipeline.

4.6.3 Distributing the load test driver

By default, Rally will generate load on the same machine where you start a benchmark. However, when you are benchmarking larger clusters, a single load test driver machine may not be able to generate sufficient load. In these cases, you should use multiple load driver machines. We will use the following configuration for the example:

- You will start Rally on `10.5.5.5`. We will call this machine the “benchmark coordinator”.
- You will start two load drivers on `10.5.5.6` and `10.5.5.7`. Note that one load driver will simulate multiple clients. Rally will simply assign clients to load driver machines in a round-robin fashion.

- Your Elasticsearch cluster will consist of three nodes which run on 10.5.5.11, 10.5.5.12 and 10.5.5.13. We will call these machines the “benchmark candidate”. For simplicity, we will assume an externally provisioned cluster but you can also use Rally to setup the cluster for you (see above).

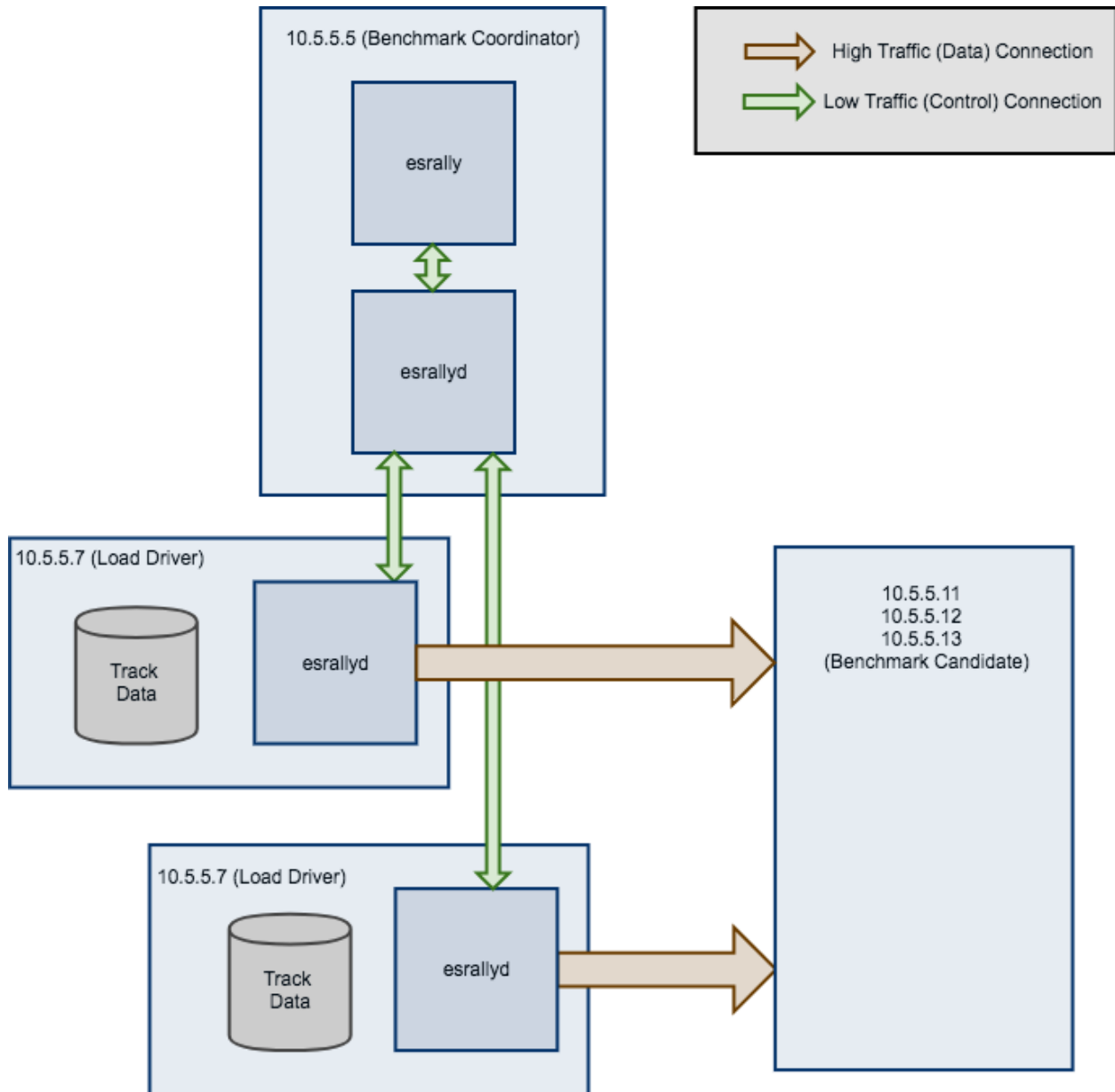

- Install* and *configure* Rally on all machines. Be sure that the same version is installed on all of them and fully *configured*.
- Start the *Rally daemon* on each machine. The Rally daemon allows Rally to communicate with all remote machines. On the benchmark coordinator run `esrallyd start --node-ip=10.5.5.5 --coordinator-ip=10.5.5.5` and on the load driver machines run `esrallyd start --node-ip=10.5.5.6 --coordinator-ip=10.5.5.5` and `esrallyd start --node-ip=10.5.5.7 --coordinator-ip=10.5.5.5` respectively. The `--node-ip` parameter tells Rally the IP of the machine on which it is running. As some machines have more than one network interface, Rally will not attempt to auto-detect the machine IP. The `--coordinator-ip` parameter tells Rally the IP of the benchmark coordinator node.

3. Start the benchmark by invoking Rally on the benchmark coordinator, for example: `esrally --pipeline=benchmark-only --load-driver-hosts=10.5.5.6,10.5.5.7 --target-hosts=10.5.5.11:9200,10.5.5.12:9200,10.5.5.13:9200`.
4. After the benchmark has finished you can stop the Rally daemon again. On the benchmark coordinator and on the load driver machines run `esrallyd stop`.

: Rally neither distributes code (i.e. *custom runners* or *parameter sources*) nor data automatically. You should place all tracks and their data on all machines in the same directory before starting the benchmark. Alternatively, you can store your track in a custom track repository.

: As indicated in the diagram, track data will be downloaded by each load driver machine separately. If you want to avoid that, you can run a benchmark once without distributing the load test driver (i.e. do not specify `--load-driver-hosts`) and then copy the contents of `~/.rally/benchmarks/data` to all load driver machines.

4.6.4 Changing the default track repository

Rally supports multiple track repositories. This allows you for example to have a separate company-internal repository for your own tracks that is separate from Rally's default track repository. However, you always need to define `--track-repository=my-custom-repository` which can be cumbersome. If you want to avoid that and want Rally to use your own track repository by default you can just replace the default track repository definition in `~/.rally/rally.ini`. Consider this example:

```
...
[tracks]
default.url = git@github.com:elastic/rally-tracks.git
teamtrackrepo.url = git@example.org/myteam/my-tracks.git
```

If `teamtrackrepo` should be the default track repository, just define it as `default.url`. E.g.:

```
...
[tracks]
default.url = git@example.org/myteam/my-tracks.git
old-rally-default.url=git@github.com:elastic/rally-tracks.git
```

Also don't forget to rename the folder of your local working copy as Rally will search for a track repository with the name `default`:

```
cd ~/.rally/benchmarks/tracks/
mv default old-rally-default
mv teamtrackrepo default
```

From now on, Rally will treat your repository as default and you need to run Rally with `--track-repository=old-rally-default` if you want to use the out-of-the-box Rally tracks.

4.7 Define Custom Workloads: Tracks

4.7.1 Definition

A track is the specification of one or more benchmarking scenarios with a specific document corpus.

: Please see the *track reference* for more information on the structure of a track.

4.7.2 Example track

Let's create an example track step by step. We will call this track "tutorial". The track consists of two components: the data and the actual track specification which describes the workload that Rally should apply. We will store everything in the directory `~/rally-tracks/tutorial` but you can choose any other location.

First, we need some data. Geonames provides geo data under a [creative commons license](#). We will download `allCountries.zip` (around 300MB), extract it and inspect `allCountries.txt`.

You will note that the file is tab-delimited but we need JSON to bulk-index data with Elasticsearch. So we can use a small script to do the conversion for us:

```
import json

cols = (("geonameid", "int", True),
        ("name", "string", True),
        ("asciiname", "string", False),
        ("alternatenames", "string", False),
        ("latitude", "double", True),
        ("longitude", "double", True),
        ("feature_class", "string", False),
        ("feature_code", "string", False),
        ("country_code", "string", True),
        ("cc2", "string", False),
        ("admin1_code", "string", False),
        ("admin2_code", "string", False),
        ("admin3_code", "string", False),
        ("admin4_code", "string", False),
        ("population", "long", True),
        ("elevation", "int", False),
        ("dem", "string", False),
        ("timezone", "string", False))

def main():
    with open("allCountries.txt", "rt", encoding="UTF-8") as f:
        for line in f:
            tup = line.strip().split("\t")
            record = {}
            for i in range(len(cols)):
                name, type, include = cols[i]
                if tup[i] != "" and include:
                    if type in ("int", "long"):
                        record[name] = int(tup[i])
                    elif type == "double":
                        record[name] = float(tup[i])
                    elif type == "string":
```

```
        record[name] = tup[i]
    print(json.dumps(record, ensure_ascii=False))

if __name__ == "__main__":
    main()
```

Store the script as `toJSON.py` in our tutorial directory (`~/rally-tracks/tutorial`) and invoke the script with `python3 toJSON.py > documents.json`.

We also need a mapping file for our documents. Store the following snippet as `index.json` in the tutorial directory:

```
{
  "settings": {
    "index.number_of_replicas": 0
  },
  "mappings": {
    "docs": {
      "dynamic": "strict",
      "properties": {
        "geonameid": {
          "type": "long"
        },
        "name": {
          "type": "text"
        },
        "latitude": {
          "type": "double"
        },
        "longitude": {
          "type": "double"
        },
        "country_code": {
          "type": "text"
        },
        "population": {
          "type": "long"
        }
      }
    }
  }
}
```

For details on the allowed syntax, see the Elasticsearch documentation on [mappings](#) and the [create index API](#).

Finally, add a file called `track.json` in the tutorial directory:

```
{
  "description": "Tutorial benchmark for Rally",
  "indices": [
    {
      "name": "geonames",
      "auto-managed": false,
      "body": "index.json",
      "types": [ "docs" ]
    }
  ],
  "corpora": [
    {
```

```

"name": "rally-tutorial",
"documents": [
  {
    "source-file": "documents.json",
    "document-count": 11658903,
    "uncompressed-bytes": 1544799789
  }
]
},
"challenges": [
  {
    "name": "index-and-query",
    "default": true,
    "schedule": [
      {
        "operation": {
          "operation-type": "delete-index"
        }
      },
      {
        "operation": {
          "operation-type": "create-index"
        }
      },
      {
        "operation": {
          "operation-type": "cluster-health",
          "request-params": {
            "wait_for_status": "green"
          }
        }
      },
      {
        "operation": {
          "operation-type": "bulk",
          "bulk-size": 5000
        },
        "warmup-time-period": 120,
        "clients": 8
      },
      {
        "operation": {
          "operation-type": "force-merge"
        }
      },
      {
        "operation": {
          "name": "query-match-all",
          "operation-type": "search",
          "body": {
            "query": {
              "match_all": {}
            }
          }
        }
      },
      "clients": 8,
      "warmup-iterations": 1000,

```

Rally will postprocess all data file names of a track. So instead of `documents.json`, Rally will attempt to find `documents-1k.json` and will assume it contains 1.000 documents. However, you need to prepare these data files otherwise this test mode is not supported.

The preparation is very easy. Just pick 1.000 documents for every data file in your track. We choose the first 1.000 here but it does not matter usually which part you choose: `head -n 1000 documents.json > documents-1k.json`.

4.7.4 Structuring your track

`track.json` is just the entry point to a track but you can split your track as you see fit. Suppose you want to add more challenges to the track above but you want to keep them in a separate files. Let's start by storing our challenge in a separate file, e.g in `challenges/index-and-query.json`. Create the directory and store the following in `index-and-query.json`:

```
{
  "name": "index-and-query",
  "default": true,
  "schedule": [
    {
      "operation": {
        "operation-type": "delete-index"
      }
    },
    {
      "operation": {
        "operation-type": "create-index"
      }
    },
    {
      "operation": {
        "operation-type": "cluster-health",
        "request-params": {
          "wait_for_status": "green"
        }
      }
    },
    {
      "operation": {
        "operation-type": "bulk",
        "bulk-size": 5000
      },
      "warmup-time-period": 120,
      "clients": 8
    },
    {
      "operation": {
        "operation-type": "force-merge"
      }
    },
    {
      "operation": {
        "name": "query-match-all",
        "operation-type": "search",
        "body": {
          "query": {
            "match_all": {}
          }
        }
      }
    }
  ]
}
```

```
    }
  },
  "clients": 8,
  "warmup-iterations": 1000,
  "iterations": 1000,
  "target-throughput": 100
}
]
```

Now modify `track.json` so it knows about your new file:

```
{
  "description": "Tutorial benchmark for Rally",
  "indices": [
    {
      "name": "geonames",
      "auto-managed": false,
      "body": "index.json",
      "types": [ "docs" ]
    }
  ],
  "corpora": [
    {
      "name": "rally-tutorial",
      "documents": [
        {
          "source-file": "documents.json",
          "document-count": 11658903,
          "uncompressed-bytes": 1544799789
        }
      ]
    }
  ],
  "challenges": [
    {% include "challenges/index-and-query.json" %}
  ]
}
```

We replaced the challenge content with `{% include "challenges/index-and-query.json" %}` which tells Rally to include the challenge from the provided file. You can use `include` on arbitrary parts of your track.

If you want to reuse operation definitions across challenges, you can also define them in a separate operations block and just refer to them by name in the corresponding challenge:

```
{
  "description": "Tutorial benchmark for Rally",
  "indices": [
    {
      "name": "geonames",
      "auto-managed": false,
      "body": "index.json",
      "types": [ "docs" ]
    }
  ],
  "corpora": [
    {
```

```

    "name": "rally-tutorial",
    "documents": [
      {
        "source-file": "documents.json",
        "document-count": 11658903,
        "uncompressed-bytes": 1544799789
      }
    ]
  },
  "operations": [
    {
      "name": "delete",
      "operation-type": "delete-index"
    },
    {
      "name": "create",
      "operation-type": "create-index"
    },
    {
      "name": "wait-for-green",
      "operation-type": "cluster-health",
      "request-params": {
        "wait_for_status": "green"
      }
    },
    {
      "name": "bulk-index",
      "operation-type": "bulk",
      "bulk-size": 5000
    },
    {
      "name": "force-merge",
      "operation-type": "force-merge"
    },
    {
      "name": "query-match-all",
      "operation-type": "search",
      "body": {
        "query": {
          "match_all": {}
        }
      }
    }
  ],
  "challenges": [
    {% include "challenges/index-and-query.json" %}
  ]
}

```

challenges/index-and-query.json then becomes:

```

{
  "name": "index-and-query",
  "default": true,
  "schedule": [
    {
      "operation": "delete"
    }
  ]
}

```

```

    },
    {
      "operation": "create"
    },
    {
      "operation": "wait-for-green"
    },
    {
      "operation": "bulk-index",
      "warmup-time-period": 120,
      "clients": 8
    },
    {
      "operation": "force-merge"
    },
    {
      "operation": "query-match-all",
      "clients": 8,
      "warmup-iterations": 1000,
      "iterations": 1000,
      "target-throughput": 100
    }
  ]
}

```

Note how we reference to the operations by their name (e.g. `create`, `bulk-index`, `force-merge` or `query-match-all`).

If your track consists of multiple challenges, it can be cumbersome to include them all explicitly. Therefore Rally brings a `collect` helper that collects all related files for you. Let's adapt our track to use it:

```

{% import "rally.helpers" as rally %}
{
  "description": "Tutorial benchmark for Rally",
  "indices": [
    {
      "name": "geonames",
      "auto-managed": false,
      "body": "index.json",
      "types": [ "docs" ]
    }
  ],
  "corpora": [
    {
      "name": "rally-tutorial",
      "documents": [
        {
          "source-file": "documents.json",
          "document-count": 11658903,
          "uncompressed-bytes": 1544799789
        }
      ]
    }
  ],
  "operations": [
    {
      "name": "delete",
      "operation-type": "delete-index"
    }
  ]
}

```

```

    },
    {
      "name": "create",
      "operation-type": "create-index"
    },
    {
      "name": "wait-for-green",
      "operation-type": "cluster-health",
      "request-params": {
        "wait_for_status": "green"
      }
    },
    {
      "name": "bulk-index",
      "operation-type": "bulk",
      "bulk-size": 5000
    },
    {
      "name": "force-merge",
      "operation-type": "force-merge"
    },
    {
      "name": "query-match-all",
      "operation-type": "search",
      "body": {
        "query": {
          "match_all": {}
        }
      }
    }
  ],
  "challenges": [
    {{ rally.collect(parts="challenges/*.json") }}
  ]
}

```

We changed two things here. First, we imported helper functions from Rally by adding `{% import "rally.helpers" as rally %}` in line 1. Second, we used Rally's `collect` helper to find and include all JSON files in the "challenges" subdirectory with the statement `{{ rally.collect(parts="challenges/*.json") }}`. When you add new challenges in this directory, Rally will automatically pick them up.

: If you want to check the final result, please check Rally's log file. Rally will print the fully rendered track there after it has loaded it successfully.

: If you define multiple challenges, Rally will run the challenge where `default` is set to `true`. If you want to run a different challenge, provide the command line option `--challenge=YOUR_CHALLENGE_NAME`.

You can even use [Jinja2 variables](#) but you need to import the Rally helpers a bit differently then. You also need to declare all variables before the `import` statement:

```

{% set clients = 16 %}
{% import "rally.helpers" as rally with context %}

```

If you use this idiom you can then refer to variables inside your snippets with `{{ clients }}`.

4.7.5 Sharing your track with others

At the moment your track is only available on your local machine but maybe you want to share it with other people in your team. You can share the track itself in any way you want, e.g. you can check it into version control. However, you will most likely not want to commit the potentially huge data file. Therefore, you can expose the data via http (e.g. via S3) and Rally can download it from there. To make this work, you need to add an additional property `base-url` for each document corpus which contains the URL from where to download your documents. Rally expects that the URL points to the parent path and will append the document file name automatically.

It is also recommended that you compress your document corpus to save network bandwidth. We recommend to use `bzip2` compression. You can create a compressed archive with the following command:

```
bzip2 -9 -c documents.json > documents.json.bz2
```

If you want to support the test mode, don't forget to also compress your test mode corpus with:

```
bzip2 -9 -c documents-1k.json > documents-1k.json.bz2
```

Then upload `documents.json.bz2` and `documents-1k.json.bz2` to the remote location.

Finally, specify the compressed file name in your `track.json` file in the `source-file` property and also add the `base-url` property:

```
{
  "description": "Tutorial benchmark for Rally",
  "corpora": [
    {
      "name": "rally-tutorial",
      "documents": [
        {
          "base-url": "http://benchmarks.elasticsearch.org.s3.amazonaws.com/corpora/
↪geonames",
          "source-file": "documents.json.bz2",
          "document-count": 11658903,
          "compressed-bytes": 197857614,
          "uncompressed-bytes": 1544799789
        }
      ]
    }
  ],
  ...
}
```

Specifying `compressed-bytes` (file size of `documents.json.bz2`) and `uncompressed-bytes` (file size of `documents.json`) is optional but helps Rally to provide progress indicators and also verify integrity.

You've now mastered the basics of track development for Rally. It's time to pat yourself on the back before you dive into the advanced topics!

4.7.6 Advanced topics

Template Language

Rally uses [Jinja2](#) as template language. This allows you to use Jinja2 expressions in track files.

Extension Points

Rally also provides a few extension points to Jinja2:

- `now`: This is a global variable that represents the current date and time when the template is evaluated by Rally.
- `days_ago()`: This is a [filter](#) that you can use for date calculations.

You can find an example in the `http_logs` track:

```
{
  "name": "range",
  "index": "logs-*",
  "type": "type",
  "body": {
    "query": {
      "range": {
        "@timestamp": {
          "gte": "now-{{ '15-05-1998' | days_ago(now) }}d/d",
          "lt": "now/d"
        }
      }
    }
  }
}
```

The data set that is used in the `http_logs` track starts on 26-04-1998 but we want to ignore the first few days for this query, so we start on 15-05-1998. The expression `{{ '15-05-1998' | days_ago(now) }}` yields the difference in days between now and the fixed start date and allows us to benchmark time range queries relative to now with a predetermined data set.

Custom parameter sources

: This is a rather new feature and the API may change! However, the effort to use custom parameter sources is very low.

: Your parameter source is on a performance-critical code-path so please double-check with *Rally's profiling support* that you did not introduce any bottlenecks.

Consider the following operation definition:

```
{
  "name": "term",
  "operation-type": "search",
  "body": {
    "query": {
      "term": {
        "body": "physician"
      }
    }
  }
}
```

This query is defined statically in the track specification but sometimes you may want to vary parameters, e.g. search also for “mechanic” or “nurse”. In this case, you can write your own “parameter source” with a little bit of Python code.

First, define the name of your parameter source in the operation definition:

```
{
  "name": "term",
  "operation-type": "search",
  "param-source": "my-custom-term-param-source"
  "professions": ["mechanic", "physician", "nurse"]
}
```

Rally will recognize the parameter source and looks then for a file `track.py` in the same directory as the corresponding JSON file. This file contains the implementation of the parameter source:

```
import random

def random_profession(track, params, **kwargs):
    # choose a suitable index: if there is only one defined for this track
    # choose that one, but let the user always override index and type.
    if len(track.indices) == 1:
        default_index = track.indices[0].name
        if len(track.indices[0].types) == 1:
            default_type = track.indices[0].types[0].name
        else:
            default_type = None
    else:
        default_index = "_all"
        default_type = None

    index_name = params.get("index", default_index)
    type_name = params.get("type", default_type)

    # you must provide all parameters that the runner expects
    return {
        "body": {
            "query": {
                "term": {
                    "body": "%s" % random.choice(params["professions"])
                }
            }
        },
        "index": index_name,
        "type": type_name,
        "use_request_cache": params.get("cache", False)
    }

def register(registry):
    registry.register_param_source("my-custom-term-param-source", random_profession)
```

The example above shows a simple case that is sufficient if the operation to which your parameter source is applied is idempotent and it does not matter whether two clients execute the same operation.

The function `random_profession` is the actual parameter source. Rally will bind the name “my-custom-term-param-source” to this function by calling `register`. `register` is called by Rally before the track is executed.

The parameter source function needs to declare the parameters `track`, `params` and `**kwargs`. `track` contains

a structured representation of the current track and `params` contains all parameters that have been defined in the operation definition in `track.json`. The third parameter is there to ensure a more stable API as Rally evolves. We use it in the example to read the professions to choose.

We also derive an appropriate index and document type from the track's index definitions but allow the user to override this choice with the `index` or `type` parameters as you can see below:

```
{
  "name": "term",
  "operation-type": "search",
  "param-source": "my-custom-term-param-source"
  "professions": ["mechanic", "physician", "nurse"],
  "index": "employee*",
  "type": "docs"
}
```

If you need more control, you need to implement a class. The example above, implemented as a class looks as follows:

```
import random

class TermParamSource:
    def __init__(self, track, params, **kwargs):
        # choose a suitable index: if there is only one defined for this track
        # choose that one, but let the user always override index and type.
        if len(track.indices) == 1:
            default_index = track.indices[0].name
            if len(track.indices[0].types) == 1:
                default_type = track.indices[0].types[0].name
            else:
                default_type = None
        else:
            default_index = "_all"
            default_type = None

        # we can eagerly resolve these parameters already in the constructor...
        self._index_name = params.get("index", default_index)
        self._type_name = params.get("type", default_type)
        self._cache = params.get("cache", False)
        # ... but we need to resolve "profession" lazily on each invocation later
        self._params = params

    def partition(self, partition_index, total_partitions):
        return self

    def size(self):
        return 1

    def params(self):
        # you must provide all parameters that the runner expects
        return {
            "body": {
                "query": {
                    "term": {
                        "body": "%s" % random.choice(self._params["professions"])
                    }
                }
            },
            "index": self._index_name,
```

```
        "type": self._type_name,
        "use_request_cache": self._cache
    }

def register(registry):
    registry.register_param_source("my-custom-term-param-source", TermParamSource)
```

Let's walk through this code step by step:

- Note the method `register` where you need to bind the name in the track specification to your parameter source implementation class similar to the simple example.
- The class `TermParamSource` is the actual parameter source and needs to fulfill a few requirements:
 - It needs to have a constructor with the signature `__init__(self, track, params, **kwargs)`. You don't need to store these parameters if you don't need them.
 - `partition(self, partition_index, total_partitions)` is called by Rally to "assign" the parameter source across multiple clients. Typically you can just return `self` but in certain cases you need to do something more sophisticated. If each clients needs to act differently then you can provide different parameter source instances here.
 - `size(self)`: This method is needed to help Rally provide a proper progress indication to users if you use a warmup time period. For bulk indexing, this would return the number of bulks (for a given client). As searches are typically executed with a pre-determined amount of iterations, just return `1` in this case.
 - `params(self)`: This method needs to return a dictionary with all parameters that the corresponding "runner" expects. For the standard case, Rally provides most of these parameters as a convenience, but here you need to define all of them yourself. This method will be invoked once for every iteration during the race. We can see that we randomly select a profession from a list which will be then be executed by the corresponding runner.

: Be aware that `params(self)` is called on a performance-critical path so don't do anything in this method that takes a lot of time (avoid any I/O). For searches, you should usually throttle throughput anyway and there it does not matter that much but if the corresponding operation is run without throughput throttling, please double-check that you did not introduce a bottleneck in the load test driver with your custom parameter source.

In the implementation of custom parameter sources you can access the Python standard API. Using any additional libraries is not supported.

You can also implement your parameter sources and runners in multiple Python files but the main entry point is always `track.py`. The root package name of your plugin is the name of your track.

Custom runners

: Your runner is on a performance-critical code-path so please double-check with *Rally's profiling support* that you did not introduce any bottlenecks.

You cannot only define custom parameter sources but also custom runners. Runners execute an operation against Elasticsearch. Out of the box, Rally supports the following operations:

- Bulk indexing
- Force merge

- Searches
- Index stats
- Nodes stats

If you want to use any other operation, you can define a custom runner. Consider, we want to use the percolate API with an older version of Elasticsearch (note that it has been replaced by the percolate query in Elasticsearch 5.0). To achieve this, we c

In `track.json` specify an operation with type “percolate” (you can choose this name freely):

```
{
  "name": "percolator_with_content_google",
  "operation-type": "percolate",
  "body": {
    "doc": {
      "body": "google"
    },
    "track_scores": true
  }
}
```

Then create a file `track.py` next to `track.json` and implement the following two functions:

```
def percolate(es, params):
    es.percolate(
        index="queries",
        doc_type="content",
        body=params["body"]
    )

def register(registry):
    registry.register_runner("percolate", percolate)
```

The function `percolate` is the actual runner and takes the following parameters:

- `es`, which is the Elasticsearch Python client
- `params` which is a dict of parameters provided by its corresponding parameter source. Treat this parameter as read only and do not attempt to write to it.

This function can return either:

- Nothing at all. Then Rally will assume that by default 1 and "ops" (see below)
- A tuple of `weight` and a `unit`, which is usually 1 and "ops". If you run a bulk operation you might return the bulk size here, for example in number of documents or in MB. Then you'd return for example (5000, "docs") Rally will use these values to store throughput metrics.
- A dict with arbitrary keys. If the dict contains the key `weight` it is assumed to be numeric and chosen as `weight` as defined above. The key `unit` is treated similarly. All other keys are added to the `meta` section of the corresponding service time and latency metrics records.

Similar to a parameter source you also need to bind the name of your operation type to the function within `register`.

If you need more control, you can also implement a runner class. The example above, implemented as a class looks as follows:

```
class PercolateRunner:
    def __enter__(self):
```

```

    return self

    def __call__(self, es, params):
        es.percolate(
            index="queries",
            doc_type="content",
            body=params["body"]
        )

    def __repr__(self, *args, **kwargs):
        return "percolate"

def register(registry):
    registry.register_runner("percolate", PercolateRunner())

```

The actual runner is implemented in the method `__call__` and the same return value conventions apply as for functions. For debugging purposes you should also implement `__repr__` and provide a human-readable name for your runner. Finally, you need to register your runner in the `register` function. Runners also support Python's [context manager](#) interface. Rally uses a new context for each request. Implementing the context manager interface can be handy for cleanup of resources after executing an operation. Rally uses it for example to clear open scrolls.

: You need to implement `register` just once and register all parameter sources and runners there.

Custom schedulers

: Your scheduler is on a performance-critical code-path so please double-check with *Rally's profiling support* that you did not introduce any bottlenecks.

If you want to rate-limit execution of tasks, you can specify a `target-throughput` (in operations per second). For example, Rally will attempt to run this term query 20 times per second:

```

{
  "operation": "term",
  "target-throughput": 20
}

```

By default, Rally will use a [deterministic distribution](#) to determine when to schedule the next operation. This means, that it will execute the term query at 0, 50ms, 100ms, 150ms and so on. Note that the scheduler is aware of the number of clients. Consider this example:

```

{
  "operation": "term",
  "target-throughput": 20,
  "clients": 4
}

```

If Rally would not take the number of clients into account and would still issue requests (from each of the four clients) at the same points in time (i.e. 0, 50ms, 100ms, 150ms, ...), it would run at a target throughput of $4 * 20 = 80$ operations per second. Hence, Rally will automatically reduce the rate at which each client will execute requests. Each client will issue requests at 0, 200ms, 400ms, 600ms, 800ms, 1000ms and so on. Each client issues five requests per second but as there are four of them, we still have a target throughput of 20 operations per second. You should keep this in mind, when writing your own custom schedules.

If you want to create a custom scheduler, create a file `track.py` next to `track.json` and implement the following two functions:

```
import random

def random_schedule(current):
    return current + random.randint(10, 900) / 1000.0

def register(registry):
    registry.register_scheduler("my_random", random_schedule)
```

You can then use your custom scheduler as follows:

```
{
  "operation": "term",
  "schedule": "my_random"
}
```

The function `random_schedule` returns a floating point number which represents the next point in time when Rally should execute the given operation. This point in time is measured in seconds relative to the beginning of the execution of this task. The parameter `current` is the last return value of your function and is 0 for the first invocation. So, for example, this scheduler could return the following series: 0, 0.119, 0.622, 1.29, 1.343, 1.984, 2.233. Note that this implementation is usually not sufficient as it does not take into account the number of clients. Therefore, you will typically want to implement a full-blown scheduler which can also take parameters. Below is an example for our random scheduler:

```
import random

class RandomScheduler:
    def __init__(self, params):
        # assume one client by default
        clients = self.params.get("clients", 1)
        # scale accordingly with the number of clients!
        self.lower_bound = clients * self.params.get("lower-bound-millis", 10)
        self.upper_bound = clients * self.params.get("upper-bound-millis", 900)

    def next(self, current):
        return current + random.randint(self.lower_bound, self.upper_bound) / 1000.0

def register(registry):
    registry.register_scheduler("my_random", RandomScheduler)
```

This implementation will now achieve the same rate independent of the number of clients. Additionally, we can pass the lower and upper bound for the random function from our track:

```
{
  "operation": "term",
  "schedule": "my_random",
  "clients": 4,
  "lower-bound-millis": 50,
  "upper-bound-millis": 250
}
```

4.8 Developing Rally

4.8.1 Prerequisites

Please ensure that the following packages are installed before installing Rally in development mode:

- Python 3.4 or better available as `python3` on the path (verify with: `python3 --version`)
- `pip3` available on the path (verify with `pip3 --version`)
- JDK 8 or 9
- git 1.9 or better
- Gradle 3.3 or better

Please check the [installation guide](#) for detailed installation instructions for these packages.

Rally does not support Windows and is only actively tested on MacOS and Linux.

4.8.2 Installation Instructions for Development

```
git clone https://github.com/elastic/rally.git
cd rally
./rally
```

If you get errors during installation, it is probably due to the installation of `psutil` which we use to gather system metrics like CPU utilization. Please check the [installation instructions of psutil](#) in this case. Keep in mind that Rally is based on Python 3 and you need to install the Python 3 header files instead of the Python 2 header files on Linux.

Automatic Updates

Rally has a built-in auto-update feature when you install it from sources. By default, it will update from the remote named `origin`. If you want to auto-update from a different remote, provide `--update-from-remote=YOUR_REMOTE_NAME` as first parameter.

To work conveniently with Rally, we suggest that you add the Rally project directory to your `PATH`. In case you use a different remote, you should also define aliases in your shell's config file, e.g.:

```
alias rally='rally --update-from-remote=elastic '
alias rallyd='rallyd --update-from-remote=elastic '
```

Then you can invoke Rally or the *Rally daemon* as usual and have auto-update still work.

Also note that automatic updates are disabled in the following cases:

- There are local (uncommitted) changes in the Rally project directory
- A different branch than `master` is checked out
- You have specified `--skip-update` as the first command line parameter
- You have specified `--offline` as a command line parameter for Rally

Configuring Rally

Before we can run our first benchmark, we have to configure Rally. Just invoke `./rally configure` and Rally will automatically detect that its configuration file is missing and prompt you for some values and write them to `~/.rally/rally.ini`. After you've configured Rally, it will exit.

For more information see [configuration help page](#).

4.8.3 Key Components of Rally

To get a rough understanding of Rally, it makes sense to get to know its key components:

- *Race Control*: is responsible for proper execution of the race. It sets up all components and acts as a high-level controller.
- *Mechanic*: can build and prepare a benchmark candidate for the race. It checks out the source, builds Elasticsearch, provisions and starts the cluster.
- *Track*: is a concrete benchmarking scenario, e.g. the `http_logs` benchmark. It defines the data set to use.
- *Challenge*: is the specification on what benchmarks should be run and its configuration (e.g. `index`, then run a search benchmark with 1000 iterations)
- *Car*: is a concrete system configuration for a benchmark, e.g. an Elasticsearch single-node cluster with default settings.
- *Driver*: drives the race, i.e. it is executing the benchmark according to the track specification.
- *Reporter*: A reporter tells us how the race went (currently only after the fact).

There is a dedicated [tutorial on how to add new tracks to Rally](#).

4.8.4 How to contribute code

First of all, please read the [contributors guide](#).

We strive to be PEP-8 compliant but don't follow it to the letter.

4.9 Command Line Reference

You can control Rally with subcommands and command line flags:

- Subcommands determine which task Rally performs.
- Command line flags are used to change Rally's behavior but not all command line flags can be used for each subcommand. To find out which command line flags are supported by a specific subcommand, just run `esrally <<subcommand>> --help`.

4.9.1 Subcommands

race

The `race` subcommand is used to actually run a benchmark. It is the default one and chosen implicitly if none is given.

list

The `list` subcommand is used to list different configuration options:

- `telemetry`: Will show all *telemetry devices* that are supported by Rally.
- `tracks`: Will show all tracks that are supported by Rally. As this *may* depend on the Elasticsearch version that you want to benchmark, you can specify `--distribution-version` and also `--distribution-repository` as additional options.
- `pipelines`: Will show all *pipelines* that are supported by Rally.
- `racers`: Will show a list of the most recent races. This is needed for the *tournament mode*.
- `cars`: Will show all cars that are supported by Rally (i.e. Elasticsearch configurations).
- `elasticsearch-plugins`: Will show all Elasticsearch plugins and their configurations that are supported by Rally.

To list a specific configuration option, place it after the `list` subcommand. For example, `esrally list pipelines` will list all pipelines known to Rally.

compare

This subcommand is needed for *tournament mode* and its usage is described there.

configure

This subcommand is needed to *configure* Rally. It is implicitly chosen if you start Rally for the first time but you can rerun this command at any time.

4.9.2 Command Line Flags

track-path

Can be either a directory that contains a `track.json` file or a `.json` file with an arbitrary name that contains a track specification. `--track-path` and `--track-repository` as well as `--track` are mutually exclusive. See the *track reference* to decide whether you should use `--track-path` or `--track-repository` / `--track`.

Examples:

```
# provide a directory - Rally searches for a track.json file in this directory
# Track name is "app-logs"
esrally --track-path=~/.Projects/tracks/app-logs
# provide a file name - Rally uses this file directly
# Track name is "syslog"
esrally --track-path=~/.Projects/tracks/syslog.json
```

track-repository

Selects the track repository that Rally should use to resolve tracks. By default the `default` track repository is used, which is available in the Github project `rally-tracks`. See the *track reference* on how to add your own track repositories. `--track-path` and `--track-repository` as well as `--track` are mutually exclusive.

track

Selects the track that Rally should run. By default the `geonames` track is run. For more details on how tracks work, see [adding tracks](#) or the [track reference](#). `--track-path` and `--track-repository` as well as `--track` are mutually exclusive.

track-params

With this parameter you can inject variables into tracks. The supported variables depend on the track and you should check the track JSON file to see which variables can be provided.

It accepts a list of comma-separated key-value pairs. The key-value pairs have to be delimited by a colon.

Examples:

Consider the following track snippet showing a single challenge:

```
{
  "name": "index-only",
  "index-settings": {
    "index.number_of_replicas": {{ replica_count|default(0) }},
    "index.number_of_shards": {{ shard_count|default(5) }},
  },
  "schedule": [
    {
      "operation": "bulk-index",
      "warmup-time-period": 120,
      "clients": 8
    }
  ]
}
```

Rally tracks can use the Jinja templating language and the construct `{{ some_variable|default(0) }}` that you can see above is a [feature of Jinja](#) to define default values for variables.

We can see that it defines two variables:

- `replica_count` with a default value of 0
- `shard_count` with a default value of 5

When we run this track, we can override these defaults:

- `--track-params="replica_count:1,shard_count:3"` will set the number of replicas to 1 and the number of shards to 3.
- `--track-params="replica_count:1"` will just set the number of replicas to 1 and just keep the default value of 5 shards.

All track parameters are recorded for each metrics record in the metrics store. Also, when you run `esrally list races`, it will show all track parameters:

Race	Timestamp	Track	Track Parameters	Challenge	Car
↪	User Tag				
↪	-----				
↪	20160518T122341Z	pmc	replica_count=1	append-no-conflicts	└
↪	defaults				
↪	20160518T112341Z	pmc	replica_count=1,shard_count=3	append-no-conflicts	└
↪	defaults				

Note that the default values are not recorded or shown (Rally does not know about them).

challenge

A track consists of one or more challenges. With this flag you can specify which challenge should be run. If you don't specify a challenge, Rally derives the default challenge itself. To see the default challenge of a track, run `esrally list tracks`.

include-tasks

Each challenge consists of one or more tasks but sometimes you are only interested to run a subset of all tasks. For example, you might have prepared an index already and want only to repeatedly run search benchmarks. Or you want to run only the indexing task but nothing else.

You can use `--include-tasks` to specify a comma-separated list of tasks that you want to run. Each item in the list defines either the name of a task or the operation type of a task. Only the tasks that match will be executed. Currently there is also no command that lists the tasks of a challenge so you need to look at the track source.

Examples:

- Execute only the tasks with the name `index` and term: `--include-tasks="index,term"`
- Execute only tasks of type `search`: `--include-tasks="type:search"`
- You can also mix and match: `--include-tasks="index,type:search"`

team-repository

Selects the team repository that Rally should use to resolve cars. By default the `default` team repository is used, which is available in the Github project [rally-teams](#). See the documentation about `cars` on how to add your own team repositories.

car

A `car` defines the Elasticsearch configuration that will be used for the benchmark. To see a list of possible cars, issue `esrally list cars`. You can specify one or multiple comma-separated values, for details please refer to the documentation about `cars`.

Example

```
esrally --car="4gheap,ea"
```

Rally will configure Elasticsearch with 4GB of heap (`4gheap`) and enable Java assertions (`ea`).

elasticsearch-plugins

A comma-separated list of Elasticsearch plugins to install for the benchmark. If a plugin supports multiple configurations you need to specify the configuration after the plugin name. To see a list of possible plugins and configurations, issue `esrally list elasticsearch-plugins`.

Example:

```
esrally --elasticsearch-plugins="analysis-icu,xpack:security"
```

In this example, Rally will install the `analysis-icu` plugin and the `x-pack` plugin with the security configuration. See the reference documentation about [Elasticsearch plugins](#) for more details.

plugin-params

Allows to override variables of Elasticsearch plugins.

Example:

```
esrally --distribution-version=6.1.1. --elasticsearch-plugins="x-pack:monitoring-http
↪" --plugin-params="monitoring_type:'https',monitoring_host:'some_remote_host',
↪monitoring_port:10200,monitoring_user:'rally',monitoring_password:'m0n1t0r1ng'"
```

This enables the HTTP exporter of X-Pack Monitoring and exports the data to the configured monitoring host.

pipeline

Selects the *pipeline* that Rally should run.

Rally can autodetect the pipeline in most cases. If you specify `--distribution-version` it will auto-select the pipeline `from-distribution` otherwise it will use `from-sources-complete`.

laps

Allows to run the benchmark for multiple laps (defaults to 1 lap). Each lap corresponds to one full execution of a track but note that the benchmark candidate is not restarted in between.

enable-driver-profiling

This option enables a profiler on all tasks that the load test driver performs. It is intended to help track authors spot accidental bottlenecks, especially if they implement their own runners or parameter sources. When this mode is enabled, Rally will enable a profiler in the load driver module. After each task and for each client, Rally will add the profile information to a dedicated profile log file. For example:

```
2017-02-09 08:23:24,35 rally.profile INFO
=== Profile START for client [0] and task [index-append-1000] ===
  16052402 function calls (15794402 primitive calls) in 180.221 seconds

  Ordered by: cumulative time

  ncalls  tottime  percall  cumtime  percall  filename:lineno(function)
↪ 130    0.001    0.000    168.089    1.293    /Users/dm/Projects/rally/esrally/driver/
↪ driver.py:908(time_period_based)
  129    0.260    0.002    168.088    1.303    /Users/dm/.rally/benchmarks/tracks/
↪ develop/bottleneck/parameter_sources/bulk_source.py:79(params)
  129000  0.750    0.000    167.791    0.001    /Users/dm/.rally/benchmarks/tracks/
↪ develop/bottleneck/parameter_sources/randomevent.py:142(generate_event)
  516000  0.387    0.000    160.485    0.000    /Users/dm/.rally/benchmarks/tracks/
↪ develop/bottleneck/parameter_sources/weightedarray.py:20(get_random)
  516000  6.199    0.000    160.098    0.000    /Users/dm/.rally/benchmarks/tracks/
↪ develop/bottleneck/parameter_sources/weightedarray.py:23(__random_index)
  516000  1.292    0.000    152.289    0.000    /usr/local/Cellar/python3/3.6.0/
↪ Frameworks/Python.framework/Versions/3.6/lib/python3.6/random.py:96(seed)
  516000  150.783  0.000    150.783    0.000    {function Random.seed at 0x10b7fa2f0}
```

```
129000 0.363 0.000 45.686 0.000 /Users/dm/.rally/benchmarks/tracks/  
↪develop/bottleneck/parameter_sources/randomevent.py:48(add_fields)  
129000 0.181 0.000 41.742 0.000 /Users/dm/.rally/benchmarks/tracks/  
↪develop/bottleneck/parameter_sources/randomevent.py:79(add_fields)  
....  
=== Profile END for client [0] and task [index-append-1000] ===
```

In this example we can spot quickly that `Random.seed` is called excessively, causing an accidental bottleneck in the load test driver.

test-mode

Allows you to test a track without running it for the whole duration. This mode is only intended for quick sanity checks when creating a track. Please don't rely on these numbers at all (they are meaningless).

If you write your own track, please keep in mind that you need *prepare your track to support this mode*.

telemetry

Activates the provided *telemetry devices* for this race.

Example

```
esrally --telemetry=jfr,jit
```

This activates Java flight recorder and the JIT compiler telemetry devices.

revision

If you actively develop Elasticsearch and want to benchmark a source build of Elasticsearch (which will Rally create for you), you can specify the git revision of Elasticsearch that you want to benchmark. But note that Rally does only support Gradle as build tool which effectively means that it will only support this for Elasticsearch 5.0 or better. The default value is `current`.

You can specify the revision in different formats:

- `--revision=latest`: Use the HEAD revision from origin/master.
- `--revision=current`: Use the current revision (i.e. don't alter the local source tree).
- `--revision=abc123`: Where abc123 is some git revision hash.
- `--revision=@2013-07-27T10:37:00Z`: Determines the revision that is closest to the provided date. Rally logs to which git revision hash the date has been resolved and if you use Elasticsearch as metrics store (instead of the default in-memory one), *each metric record will contain the git revision hash also in the meta-data section*.

Supported date format: If you specify a date, it has to be ISO-8601 conformant and must start with an @ sign to make it easier for Rally to determine that you actually mean a date.

If you want to create source builds of Elasticsearch plugins, you need to specify the revision for Elasticsearch and all relevant plugins separately. Revisions for Elasticsearch and each plugin need to be comma-separated (,). Each revision is prefixed either by `elasticsearch` or by the plugin name and separated by a colon (:). As core plugins are contained in the Elasticsearch repo, there is no need to specify a revision for them (the revision would even be ignored in fact).

Examples:

- Build latest Elasticsearch and plugin “my-plugin”: `--revision="elasticsearch:latest,my-plugin:latest"`
- Build Elasticsearch tag v5.6.1 and revision abc123 of plugin “my-plugin”: `--revision="elasticsearch:v5.6.1,my-plugin:abc123"`

Note that it is still required to provide the parameter `--elasticsearch-plugins`. Specifying a plugin with `--revision` just tells Rally which revision to use for building the artifact. See the documentation on [Elasticsearch plugins](#) for more details.

distribution-version

If you want to benchmark a binary distribution, you can specify the version here.

Example

```
esrally --distribution-version=2.3.3
```

Rally will then benchmark the official Elasticsearch 2.3.3 distribution.

Rally works with all releases of Elasticsearch that are [supported by Elastic](#).

The following versions are already end-of-life:

- 0.x: Rally is not tested, and not expected to work for this version; we will make no effort to make Rally work.
- 1.x: Rally works on a best-effort basis with this version but support may be removed at any time.

Additionally, Rally will always work with the current development version of Elasticsearch (by using either a snapshot repository or by building Elasticsearch from sources).

distribution-repository

Rally does not only support benchmarking official distributions but can also benchmark snapshot builds. This option is really just intended for [our benchmarks that are run in continuous integration](#) but if you want to, you can use it too. The only supported value out of the box is `release` (default) but you can define arbitrary repositories in `~/.rally/rally.ini`.

Example

Say, you have an in-house repository where Elasticsearch snapshot builds get published. Then you can add the following in the `distributions` section of your Rally config file:

```
in_house_snapshot.url = https://www.example.org/snapshots/elasticsearch/elasticsearch-
↳ {{VERSION}}.tar.gz
in_house_snapshot.cache = false
```

The `url` property defines the URL pattern for this repository. The `cache` property defines whether Rally should always download a new archive (`cache=false`) or just reuse a previously downloaded version (`cache=true`). Rally will replace the `{{VERSION}}` placeholder of in the `url` property with the value of `distribution-version` provided by the user on the command line.

You can use this distribution repository with the name “`in_house_snapshot`” as follows:

```
esrally --distribution-repository=in_house_snapshot --distribution-version=7.0.0-
↳ SNAPSHOT
```

This will benchmark the latest 7.0.0 snapshot build of Elasticsearch.

report-format

The command line reporter in Rally displays a table with key metrics after a race. With this option you can specify whether this table should be in `markdown` format (default) or `csv`.

show-in-report

By default, the command line reporter will only show values that are available (`available`). With `all` you can force it to show a line for every value, even undefined ones, and with `all-percentiles` it will show only available values but force output of all possible percentile values.

This command line parameter is not available for comparing races.

report-file

By default, the command line reporter will print the results only on standard output, but can also write it to a file.

Example

```
esrally --report-format=csv --report-file=~/.benchmarks/result.csv
```

client-options

With this option you can customize Rally's internal Elasticsearch client.

It accepts a list of comma-separated key-value pairs. The key-value pairs have to be delimited by a colon. These options are passed directly to the Elasticsearch Python client API. See [their documentation on a list of supported options](#).

We support the following data types:

- **Strings:** Have to be enclosed in single quotes. Example: `ca_certs: '/path/to/CA_certs'`
- **Numbers:** There is nothing special about numbers. Example: `sniffer_timeout: 60`
- **Booleans:** Specify either `true` or `false`. Example: `use_ssl: true`

In addition to the options, supported by the Elasticsearch client, it is also possible to enable HTTP compression by specifying `compressed: true`

Default value: `timeout: 60`

• If you provide your own client options, the default value will not be magically merged. You have to specify all client options explicitly. The only exceptions to this rule is `ca_cert` (see below).

Examples

Here are a few common examples:

- Enable HTTP compression: `--client-options="compressed: true"`
- Enable SSL (e.g. if you have X-Pack Security installed): `--client-options="use_ssl: true, verify_certs: true"`. Note that you don't need to set `ca_cert` (which defines the path to the root certificates). Rally does this automatically for you.

- Enable SSL with a client key and certificate: `--client-options="use_ssl:true, verify_certs:true, ca_certs:'/path/to/cacert.pem', client_cert:'/path/to/client_cert.pem', client_key='/path/to/client_key.pem'"` (see also the [Elasticsearch Python client docs](#))
- Enable basic authentication: `--client-options="basic_auth_user:'user', basic_auth_password:'password'"`. Please avoid the characters `'`, `,` and `:` in user name and password as Rally's parsing of these options is currently really simple and there is no possibility to escape characters.

on-error

This option controls whether Rally will `continue` or `abort` when a request error occurs. By default, Rally will just record errors and report the error rate at the end of a race. With `--on-error=abort`, Rally will immediately abort the race on the first error and print a detailed error message.

load-driver-hosts

By default, Rally will run its load driver on the same machine where you start the benchmark. However, if you benchmark larger clusters, one machine may not be enough to generate sufficient load. Hence, you can specify a comma-separated list of hosts which should be used to generate load with `--load-driver-hosts`.

Example

```
esrally --load-driver-hosts=10.17.20.5,10.17.20.6
```

In the example, above Rally will generate load from the hosts `10.17.20.5` and `10.17.20.6`. For this to work, you need to start a Rally daemon on these machines, see *distributing the load test driver* for a complete example.

target-hosts

If you run the `benchmark-only pipeline` or you want Rally to *benchmark a remote cluster*, then you can specify a comma-delimited list of hosts:port pairs to which Rally should connect. The default value is `127.0.0.1:9200`.

Example

```
esrally --pipeline=benchmark-only --target-hosts=10.17.0.5:9200,10.17.0.
↪6:9200
```

This will run the benchmark against the hosts `10.17.0.5` and `10.17.0.6` on port `9200`. See `client-options` if you use X-Pack Security and need to authenticate or Rally should use `https`.

quiet

Suppresses some output on the command line.

offline

Tells Rally that it should assume it has no connection to the Internet when checking for track data. The default value is `false`. Note that Rally will only assume this for tracks but not for anything else, e.g. it will still try to download Elasticsearch distributions that are not locally cached or fetch the Elasticsearch source tree.

`preserve-install`

Rally usually installs and launches an Elasticsearch cluster internally and wipes the entire directory after the benchmark is done. Sometimes you want to keep this cluster including all data after the benchmark has finished and that's what you can do with this flag. Note that depending on the track that has been run, the cluster can eat up a very significant amount of disk space (at least dozens of GB). The default value is configurable in the advanced configuration but usually `false`.

: This option does only affect clusters that are provisioned by Rally. More specifically, if you use the pipeline `benchmark-only`, this option is ineffective as Rally does not provision a cluster in this case.

`cluster-health`

: This option is deprecated and will be removed in a future version of Rally. For details, please see the respective [Github ticket #364](#).

Rally checks whether the cluster health is “green” before it runs a benchmark against it. The main reason is that we don't want to benchmark a cluster which is shuffling shards around or might start doing so. If you really need to run a benchmark against a cluster that is “yellow” or “red”, then you can explicitly override Rally's default behavior. It is even possible to skip this check entirely by providing `--cluster-health=skip`. But please think twice before doing so and rather eliminate the root cause.

Example

```
esrally --cluster-health=yellow
```

`advanced-config`

This flag determines whether Rally should present additional (advanced) configuration options. The default value is `false`.

Example

```
esrally configure --advanced-config
```

`assume-defaults`

This flag determines whether Rally should automatically accept all values for configuration options that provide a default. This is mainly intended to configure Rally automatically in CI runs. The default value is `false`.

Example

```
esrally configure --assume-defaults=true
```

`user-tag`

This is only relevant when you want to run *tournaments*. You can use this flag to attach an arbitrary text to the meta-data of each metric record and also the corresponding race. This will help you to recognize a race when you run

`esrally list races` as you don't need to remember the concrete timestamp on which a race has been run but can instead use your own descriptive names.

The required format is key ":" value. You can choose key and value freely.

Example

```
esrally --user-tag="intention:github-issue-1234-baseline,gc:cms"
```

You can also specify multiple tags. They need to be separated by a comma.

Example

```
esrally --user-tag="disk:SSD,data_node_count:4"
```

When you run `esrally list races`, this will show up again:

Race	Timestamp	Track	Track Parameters	Challenge	Car	User Tag
↪	-----					
	20160518T122341Z	pmc		append-no-conflicts	defaults	↪
	↪		intention:github-issue-1234-baseline			
	20160518T112341Z	pmc		append-no-conflicts	defaults	disk:SSD,
	↪		data_node_count:4			

This will help you recognize a specific race when running `esrally compare`.

4.10 Offline Usage

In some corporate environments servers do not have Internet access. You can still use Rally in such environments and this page summarizes all information that you need to get started.

4.10.1 Installation and Configuration

We provide a special offline installation package. Please refer to the [offline installation guide](#) for detailed instructions. After the installation you can just follow the normal [configuration procedure](#).

4.10.2 Command Line Usage

Rally will automatically detect upon startup that no Internet connection is available and print the following warning:

```
[WARNING] No Internet connection detected. Automatic download of track data sets etc.↪
↪ is disabled.
```

It detects this by trying to connect to `github.com`. If you want to disable this probing you can explicitly specify `--offline`.

4.10.3 Using tracks

A Rally track describes a benchmarking scenario. You can either write your own tracks or use the tracks that Rally provides out of the box. In the former case, Rally will work just fine in an offline environment. In the latter case, Rally would normally download the track and its associated data from the Internet. If you want to use one of Rally's

standard tracks in offline mode, you need to download all relevant files first on a machine that has Internet access and copy it to the target machine(s).

Use the [download script](#) to download all data for a track on a machine that has access to the Internet. Example:

```
# downloads the script from Github
curl -O https://raw.githubusercontent.com/elastic/rally-tracks/master/download.sh
chmod u+x download.sh
# download all data for the geonames track
./download.sh geonames
```

This will download all data for the geonames track and create a tar file `rally-track-data-geonames.tar` in the current directory. Copy this file to the home directory of the user which will execute Rally on the target machine (e.g. `/home/rally-user`).

On the target machine, run:

```
cd ~
tar -xf rally-track-data-geonames.tar
```

The download script does not require a Rally installation on the machine with Internet access but assumes that `git` and `curl` are available.

After you've copied the data, you can list the available tracks with `esrally list tracks`. If a track shows up in this list, it just means that the track description is available locally but not necessarily all data files.

4.10.4 Using cars

: You can skip this section if you use Rally only as a load generator.

If you have Rally configure and start Elasticsearch then you also need the out-of-the-box configurations available. Run the following command on a machine with Internet access:

```
git clone https://github.com/elastic/rally-teams.git ~/.rally/benchmarks/teams/default
tar -C ~ -czf rally-teams.tar.gz ~/.rally/benchmarks/teams/default
```

Copy that file to the target machine(s) and run on the target machine:

```
cd ~
tar -xzf rally-teams.tar.gz
```

After you've copied the data, you can list the available tracks with `esrally list cars`.

4.11 Track Reference

4.11.1 Definition

A track is a specification of one or more benchmarking scenarios with a specific document corpus. It defines for example the involved indices, data files and the operations that are invoked. Its most important attributes are:

- One or more indices, each with one or more types
- The queries to issue

- Source URL of the benchmark data
- A list of steps to run, which we'll call "challenge", for example indexing data with a specific number of documents per bulk request or running searches for a defined number of iterations.

4.11.2 Track File Format and Storage

A track is specified in a JSON file.

Ad-hoc use

For ad-hoc use you can store a track definition anywhere on the file system and reference it with `--track-path`, e.g:

```
# provide a directory - Rally searches for a track.json file in this directory
# Track name is "app-logs"
esrally --track-path=~/.Projects/tracks/app-logs
# provide a file name - Rally uses this file directly
# Track name is "syslog"
esrally --track-path=~/.Projects/tracks/syslog.json
```

Rally will also search for additional files like mappings or data files in the provided directory. If you use advanced features like *custom runners* or *parameter sources* we recommend that you create a separate directory per track.

Custom Track Repositories

Alternatively, you can store Rally tracks also in a dedicated git repository which we call a "track repository". Rally provides a default track repository that is hosted on [Github](#). You can also add your own track repositories although this requires a bit of additional work. First of all, track repositories need to be managed by git. The reason is that Rally can benchmark multiple versions of Elasticsearch and we use git branches in the track repository to determine the best match for each track (based on the command line parameter `--distribution-version`). The versioning scheme is as follows:

- The *master* branch needs to work with the latest *master* branch of Elasticsearch.
- All other branches need to match the version scheme of Elasticsearch, i.e. `MAJOR.MINOR.PATCH-SUFFIX` where all parts except `MAJOR` are optional.

Rally implements a fallback logic so you don't need to define a branch for each patch release of Elasticsearch. For example:

- The branch `6.0.0-alpha1` will be chosen for the version `6.0.0-alpha1` of Elasticsearch.
- The branch `5` will be chosen for all versions for Elasticsearch with the major version 5, e.g. `5.0.0`, `5.1.3` (provided there is no specific branch).

Rally tries to use the branch with the best match to the benchmarked version of Elasticsearch.

Rally will also search for related files like mappings or custom runners or parameter sources in the track repository. However, Rally will use a separate directory to look for data files (`~/.rally/benchmarks/data/$TRACK_NAME/`). The reason is simply that we do not want to check multi-GB data files into git.

Creating a new track repository

All track repositories are located in `~/.rally/benchmarks/tracks`. If you want to add a dedicated track repository, called `private` follow these steps:

```
cd ~/.rally/benchmarks/tracks
mkdir private
cd private
git init
# add your track now
git add .
git commit -m "Initial commit"
```

If you want to share your tracks with others you need to add a remote and push it:

```
git remote add origin git@git-repos.acme.com:acme/rally-tracks.git
git push -u origin master
```

If you have added a remote you should also add it in `~/.rally/rally.ini`, otherwise you can skip this step. Open the file in your editor of choice and add the following line in the section `tracks`:

```
private.url = <<URL_TO_YOUR_ORIGIN>>
```

Rally will then automatically update the local tracking branches before the benchmark starts.

You can now verify that everything works by listing all tracks in this track repository:

```
esrally list tracks --track-repository=private
```

This shows all tracks that are available on the `master` branch of this repository. Suppose you only created tracks on the branch `2` because you're interested in the performance of Elasticsearch 2.x, then you can specify also the distribution version:

```
esrally list tracks --track-repository=private --distribution-version=2.0.0
```

Rally will follow the same branch fallback logic as described above.

Adding an already existing track repository

If you want to add a track repository that already exists, just open `~/.rally/rally.ini` in your editor of choice and add the following line in the section `tracks`:

```
your_repo_name.url = <<URL_TO_YOUR_ORIGIN>>
```

After you have added this line, have Rally list the tracks in this repository:

```
esrally list tracks --track-repository=your_repo_name
```

When to use what?

We recommend the following path:

- Start with a simple json file. The file name can be arbitrary.
- If you need *custom runners* or *parameter sources*, create one directory per track. Then you can keep everything that is related to one track in one place. Remember that the track JSON file needs to be named `track.json`.
- If you want to version your tracks so they can work with multiple versions of Elasticsearch (e.g. you are running benchmarks before an upgrade), use a track repository.

4.11.3 Anatomy of a track

A track JSON file consists of the following sections:

- indices
- templates
- corpora
- operations
- challenges

In the `indices` and `templates` sections you define the relevant indices and index templates. These sections are optional but recommended if you want to create indices and index templates with the help of Rally.

In the `corpora` section you define all document corpora (i.e. data files) that Rally should use for this track.

In the `operations` section you describe which operations are available for this track and how they are parametrized. This section is optional and you can also define any operations directly per challenge. You can use it, if you want to share operation definitions between challenges.

In the `challenge` or `challenges` section you describe one or more execution schedules respectively. Each schedule either uses the operations defined in the `operations` block or defines the operations to execute inline. Think of a challenge as a scenario that you want to test for your data. An example challenge is to index with two clients at maximum throughput while searching with another two clients with ten operations per second.

4.11.4 Track elements

The track elements that are described here are defined in [Rally's JSON schema for tracks](#). Rally uses this track schema to validate your tracks when it is loading them.

Each track defines the following info attributes:

- `version` (optional): An integer describing the track specification version in use. Rally uses it to detect incompatible future track specification versions and raise an error. See the table below for a reference of valid versions.
- `description` (optional): A human-readable description of the track. Although it is optional, we recommend providing it.

Track Specification Version	Rally version
1	>=0.7.3, <0.10.0
2	>=0.9.0

The `version` property has been introduced with Rally 0.7.3. Rally versions before 0.7.3 do not recognize this property and thus cannot detect incompatible track specification versions.

Example:

```
{
  "version": 1,
  "description": "POIs from Geonames"
}
```

meta

For each track, an optional structure, called `meta` can be defined. You are free which properties this element should contain.

This element can also be defined on the following elements:

- `challenge`
- `operation`
- `task`

If the `meta` structure contains the same key on different elements, more specific ones will override the same key of more generic elements. The order from generic to most specific is:

1. `track`
2. `challenge`
3. `operation`
4. `task`

E.g. a key defined on a `task`, will override the same key defined on a `challenge`. All properties defined within the merged `meta` structure, will get copied into each metrics record.

indices

The `indices` section contains a list of all indices that are used by this track. By default Rally will assume that it can destroy and create these indices at will.

Each index in this list consists of the following properties:

- `name` (mandatory): The name of the index.
- `body` (optional): File name of the corresponding index definition that will be used as body in the create index API call.
- `auto-managed` (optional, defaults to `true`): Controls whether Rally or the user takes care of creating / destroying the index. If this setting is `false`, Rally will neither create nor delete this index but just assume its presence.
- `types` (optional): A list of type names in this index.

Example:

```
"indices": [  
  {  
    "name": "geonames",  
    "body": "geonames-index.json",  
    "types": ["docs"]  
  }  
]
```

templates

The `templates` section contains a list of all index templates that Rally should create.

- `name` (mandatory): Index template name

- `index-pattern` (mandatory): Index pattern that matches the index template. This must match the definition in the index template file.
- `delete-matching-indices` (optional, defaults to `true`): Delete all indices that match the provided index pattern before start of the benchmark.
- `template` (mandatory): Index template file name

Example:

```
"templates": [
  {
    "name": "my-default-index-template",
    "index-pattern": "my-index-*",
    "delete-matching-indices": true,
    "template": "default-template.json"
  }
]
```

corpora

The `corpora` section contains all document corpora that are used by this track. Note that you can reuse document corpora across tracks; just copy & paste the respective corpora definitions. It consists of the following properties:

- `name` (mandatory): Name of this document corpus. As this name is also used by Rally in directory names, it is recommended to only use lower-case names without whitespaces for maximum compatibility across file systems.
- `documents` (mandatory): A list of documents files.

Each entry in the `documents` list consists of the following properties:

- `base-url` (optional): A `http` or `https` URL that points to the root path where Rally can obtain the corresponding source file.
- `source-format` (optional, default: `bulk`): Defines in which format Rally should interpret the data file specified by `source-file`. Currently, only `bulk` is supported.
- `source-file` (mandatory): File name of the corresponding documents. For local use, this file can be a `.json` file. If you provide a `base-url` we recommend that you provide a compressed file here. The following extensions are supported: `.zip`, `.bz2`, `.gz`, `.tar`, `.tar.gz`, `.tgz` or `.tar.bz2`. It must contain exactly one JSON file with the same name. The preferred file extension for our official tracks is `.bz2`.
- `includes-action-and-meta-data` (optional, defaults to `false`): Defines whether the documents file contains already an action and meta-data line (`true`) or only documents (`false`).
- `document-count` (mandatory): Number of documents in the source file. This number is used by Rally to determine which client indexes which part of the document corpus (each of the `N` clients gets one `N`-th of the document corpus). If you are using parent-child, specify the number of parent documents.
- `compressed-bytes` (optional but recommended): The size in bytes of the compressed source file. This number is used to show users how much data will be downloaded by Rally and also to check whether the download is complete.
- `uncompressed-bytes` (optional but recommended): The size in bytes of the source file after decompression. This number is used by Rally to show users how much disk space the decompressed file will need and to check that the whole file could be decompressed successfully.
- `target-index`: Defines the name of the index which should be targeted for bulk operations. Rally will automatically derive this value if you have defined exactly one index in the `indices` section. Ignored if `includes-action-and-meta-data` is `true`.

- `target-type`: Defines the name of the document type which should be targeted for bulk operations. Rally will automatically derive this value if you have defined exactly one index in the `indices` section and this index has exactly one type. Ignored if `includes-action-and-meta-data` is `true`.

To avoid repetition, you can specify default values on document corpus level for the following properties:

- `base-url`
- `source-format`
- `includes-action-and-meta-data`
- `target-index`
- `target-type`

Examples

Here we define a single document corpus with one set of documents:

```
"corpora": [
  {
    "name": "geonames",
    "documents": [
      {
        "base-url": "http://benchmarks.elasticsearch.org.s3.amazonaws.com/corpora/
↪geonames",
        "source-file": "documents.json.bz2",
        "document-count": 11396505,
        "compressed-bytes": 264698741,
        "uncompressed-bytes": 3547614383,
        "target-index": "geonames",
        "target-type": "docs"
      }
    ]
  }
]
```

We can also define default values on document corpus level but override some of them (`base-url` for the last entry):

```
"corpora": [
  {
    "name": "http_logs",
    "base-url": "http://benchmarks.elasticsearch.org.s3.amazonaws.com/corpora/http_
↪logs",
    "target-type": "docs",
    "documents": [
      {
        "source-file": "documents-181998.json.bz2",
        "document-count": 2708746,
        "target-index": "logs-181998"
      },
      {
        "source-file": "documents-191998.json.bz2",
        "document-count": 9697882,
        "target-index": "logs-191998"
      },
      {
        "base-url": "http://example.org/corpora/http_logs",
        "source-file": "documents-201998.json.bz2",
        "document-count": 13053463,

```

```

        "target-index": "logs-201998"
      }
    ]
  }
]

```

operations

The `operations` section contains a list of all operations that are available later when specifying challenges. Operations define the static properties of a request against Elasticsearch whereas the `schedule` element defines the dynamic properties (such as the target throughput).

Each operation consists of the following properties:

- `name` (mandatory): The name of this operation. You can choose this name freely. It is only needed to reference the operation when defining schedules.
- `operation-type` (mandatory): Type of this operation. See below for the operation types that are supported out of the box in Rally. You can also add arbitrary operations by defining *custom runners*.
- `include-in-reporting` (optional, defaults to `true` for normal operations and to `false` for administrative operations): Whether or not this operation should be included in the command line report. For example you might want Rally to create an index for you but you are not interested in detailed metrics about it. Note that Rally will still record all metrics in the metrics store.

Depending on the operation type a couple of further parameters can be specified.

bulk

With the operation type `bulk` you can execute [bulk requests](#). It supports the following properties:

- `bulk-size` (mandatory): Defines the bulk size in number of documents.
- `corpora` (optional): A list of document corpus names that should be targeted by this bulk-index operation. Only needed if the `corpora` section contains more than one document corpus and you don't want to index all of them with this operation.
- `indices` (optional): A list of index names that defines which indices should be used by this bulk-index operation. Rally will then only select the documents files that have a matching `target-index` specified.
- `batch-size` (optional): Defines how many documents Rally will read at once. This is an expert setting and only meant to avoid accidental bottlenecks for very small bulk sizes (e.g. if you want to benchmark with a bulk-size of 1, you should set batch-size higher).
- `pipeline` (optional): Defines the name of an (existing) ingest pipeline that should be used (only supported from Elasticsearch 5.0).
- `conflicts` (optional): Type of index conflicts to simulate. If not specified, no conflicts will be simulated. Valid values are: `'sequential'` (A document id is replaced with a document id with a sequentially increasing id), `'random'` (A document id is replaced with a document id with a random other id).

Example:

```

{
  "name": "index-append",
  "operation-type": "bulk",
  "bulk-size": 5000
}

```

Throughput will be reported as number of indexed documents per second.

force-merge

With the operation type `force-merge` you can call the [force merge API](#). On older versions of Elasticsearch (prior to 2.1), Rally will use the `optimize` API instead. It supports the following parameter:

- `max_num_segments` (optional) The number of segments the index should be merged into. Defaults to simply checking if a merge needs to execute, and if so, executes it.

This is an administrative operation. Metrics are not reported by default. If reporting is forced by setting `include-in-reporting` to `true`, then throughput is reported as the number of completed force-merge operations per second.

index-stats

With the operation type `index-stats` you can call the [indices stats API](#). It does not support any parameters.

Throughput will be reported as number of completed `index-stats` operations per second.

node-stats

With the operation type `nodes-stats` you can execute [nodes stats API](#). It does not support any parameters.

Throughput will be reported as number of completed `node-stats` operations per second.

search

With the operation type `search` you can execute [request body searches](#). It supports the following properties:

- `index` (optional): An [index pattern](#) that defines which indices should be targeted by this query. Only needed if the `index` section contains more than one index. Otherwise, Rally will automatically derive the index to use. If you have defined multiple indices and want to query all of them, just specify `"index": "_all"`.
- `type` (optional): Defines the type within the specified index for this query.
- `cache` (optional): Whether to use the query request cache. By default, Rally will define no value thus the default depends on the benchmark candidate settings and Elasticsearch version.
- `request-params` (optional): A structure containing arbitrary request parameters. The supported parameters names are documented in the [Python ES client API docs](#). Parameters that are implicitly set by Rally (e.g. `body` or `request_cache`) are not supported (i.e. you should not try to set them and if so expect unspecified behavior).
- `body` (mandatory): The query body.
- `pages` (optional): Number of pages to retrieve. If this parameter is present, a scroll query will be executed. If you want to retrieve all result pages, use the value "all".
- `results-per-page` (optional): Number of documents to retrieve per page for scroll queries.

Example:

```
{
  "name": "default",
  "operation-type": "search",
  "body": {
```

```

    "query": {
      "match_all": {}
    },
    "request-params": {
      "_source_include": "some_field",
      "analyze_wildcard": false
    }
  }
}

```

For scroll queries, throughput will be reported as number of retrieved scroll pages per second. The unit is ops/s, where one op(eration) is one page that has been retrieved. The rationale is that each HTTP request corresponds to one operation and we need to issue one HTTP request per result page. Note that if you use a dedicated Elasticsearch metrics store, you can also use other request-level meta-data such as the number of hits for your own analyses.

For other queries, throughput will be reported as number of search requests per second, also measured as ops/s.

put-pipeline

With the operation-type `put-pipeline` you can execute the [put pipeline API](#). Note that this API is only available from Elasticsearch 5.0 onwards. It supports the following properties:

- *id* (mandatory): Pipeline id
- *body* (mandatory): Pipeline definition

Example:

```

{
  "name": "define-ip-geocoder",
  "operation-type": "put-pipeline",
  "id": "ip-geocoder",
  "body": {
    "description": "Extracts location information from the client IP.",
    "processors": [
      {
        "geoip": {
          "field": "clientip",
          "properties": [
            "city_name",
            "country_iso_code",
            "country_name",
            "location"
          ]
        }
      ]
    ]
  }
}

```

This example requires that the `ingest-geoip` Elasticsearch plugin is installed.

This is an administrative operation. Metrics are not reported by default. Reporting can be forced by setting `include-in-reporting` to `true`.

cluster-health

With the operation `cluster-health` you can execute the [cluster health API](#). It supports the following properties:

- `request-params` (optional): A structure containing any request parameters that are allowed by the cluster health API.
- `index` (optional): The name of the index that should be used to check.

The `cluster-health` operation will check whether the expected cluster health and will report a failure if this is not the case. Use `--on-error` on the command line to control Rally's behavior in case of such failures.

Example:

```
{
  "name": "check-cluster-green",
  "operation-type": "cluster-health",
  "index": "logs-*",
  "request-params": {
    "wait_for_status": "green",
    "wait_for_no_relocating_shards": "true"
  }
}
```

This is an administrative operation. Metrics are not reported by default. Reporting can be forced by setting `include-in-reporting` to `true`.

refresh

With the operation `refresh` you can execute the [refresh API](#). It supports the following properties:

- `index` (optional, defaults to `_all`): The name of the index that should be refreshed.

This is an administrative operation. Metrics are not reported by default. Reporting can be forced by setting `include-in-reporting` to `true`.

create-index

With the operation `create-index` you can execute the [create index API](#). It supports two modes: it creates either all indices that are specified in the track's `indices` section or it creates one specific index defined by this operation.

If you want it to create all indices that have been declared in the `indices` section you can specify the following properties:

- `settings` (optional): Allows to specify additional index settings that will be merged with the index settings specified in the body of the index in the `indices` section.
- `request-params` (optional): A structure containing any [request parameters](#) that are allowed by the create index API.

If you want it to create one specific index instead, you can specify the following properties:

- `index` (mandatory): The name of the index that should be created.
- `body` (optional): The body for the create index API call.
- `request-params` (optional): A structure containing any [request parameters](#) that are allowed by the create index API.

Examples

The following snippet will create all indices that have been defined in the `indices` section. It will reuse all settings defined but override the number of shards:

```
{
  "name": "create-all-indices",
  "operation-type": "create-index",
  "settings": {
    "index.number_of_shards": 1
  },
  "request-params": {
    "wait_for_active_shards": true
  }
}
```

With the following snippet we will create a new index that is not defined in the `indices` section. Note that we specify the index settings directly in the body:

```
{
  "name": "create-an-index",
  "operation-type": "create-index",
  "index": "people",
  "body": {
    "settings": {
      "index.number_of_shards": 0
    },
    "mappings": {
      "docs": {
        "properties": {
          "name": {
            "type": "text"
          }
        }
      }
    }
  }
}
```

This is an administrative operation. Metrics are not reported by default. Reporting can be forced by setting `include-in-reporting` to `true`.

delete-index

With the operation `delete-index` you can execute the [delete index API](#). It supports two modes: it deletes either all indices that are specified in the track's `indices` section or it deletes one specific index (pattern) defined by this operation.

If you want it to delete all indices that have been declared in the `indices` section, you can specify the following properties:

- `only-if-exists` (optional, defaults to `true`): Defines whether an index should only be deleted if it exists.
- `request-params` (optional): A structure containing any [request parameters](#) that are allowed by the delete index API.

If you want it to delete one specific index (pattern) instead, you can specify the following properties:

- `index` (mandatory): The name of the index that should be deleted.

- `only-if-exists` (optional, defaults to `true`): Defines whether an index should only be deleted if it exists.
- `request-params` (optional): A structure containing any [request parameters](#) that are allowed by the delete index API.

Examples

With the following snippet we will delete all indices that are declared in the `indices` section but only if they existed previously (implicit default):

```
{
  "name": "delete-all-indices",
  "operation-type": "delete-index"
}
```

With the following snippet we will delete all `logs-*` indices:

```
{
  "name": "delete-logs",
  "operation-type": "delete-index",
  "index": "logs-*",
  "only-if-exists": false,
  "request-params": {
    "expand_wildcards": "all",
    "allow_no_indices": true,
    "ignore_unavailable": true
  }
}
```

This is an administrative operation. Metrics are not reported by default. Reporting can be forced by setting `include-in-reporting` to `true`.

create-index-template

With the operation `create-index-template` you can execute the [create index template API](#). It supports two modes: it creates either all index templates that are specified in the track's `templates` section or it creates one specific index template defined by this operation.

If you want it to create index templates that have been declared in the `templates` section you can specify the following properties:

- `template` (optional): If you specify a template name, only the template with this name will be created.
- `settings` (optional): Allows to specify additional settings that will be merged with the settings specified in the body of the index template in the `templates` section.
- `request-params` (optional): A structure containing any [request parameters](#) that are allowed by the create index template API.

If you want it to create one specific index instead, you can specify the following properties:

- `template` (mandatory): The name of the index template that should be created.
- `body` (mandatory): The body for the create index template API call.
- `request-params` (optional): A structure containing any [request parameters](#) that are allowed by the create index template API.

Examples

The following snippet will create all index templates that have been defined in the `templates` section:

```
{
  "name": "create-all-templates",
  "operation-type": "create-index-template",
  "request-params": {
    "create": true
  }
}
```

With the following snippet we will create a new index template that is not defined in the `templates` section. Note that we specify the index template settings directly in the body:

```
{
  "name": "create-a-template",
  "operation-type": "create-index-template",
  "template": "defaults",
  "body": {
    "index_patterns": ["*"],
    "settings": {
      "number_of_shards": 3
    },
    "mappings": {
      "docs": {
        "_source": {
          "enabled": false
        }
      }
    }
  }
}
```

This is an administrative operation. Metrics are not reported by default. Reporting can be forced by setting `include-in-reporting` to `true`.

delete-index-template

With the operation `delete-index-template` you can execute the [delete index template API](#). It supports two modes: it deletes either all index templates that are specified in the track's `templates` section or it deletes one specific index template defined by this operation.

If you want it to delete all index templates that have been declared in the `templates` section, you can specify the following properties:

- `only-if-exists` (optional, defaults to `true`): Defines whether an index template should only be deleted if it exists.
- `request-params` (optional): A structure containing any [request parameters](#) that are allowed by the delete index template API.

If you want it to delete one specific index template instead, you can specify the following properties:

- `template` (mandatory): The name of the index that should be deleted.
- `only-if-exists` (optional, defaults to `true`): Defines whether the index template should only be deleted if it exists.
- `delete-matching-indices` (optional, defaults to `false`): Whether to delete indices that match the index template's index pattern.

- `index-pattern` (mandatory iff `delete-matching-indices` is `true`): Specifies the index pattern to delete.
- `request-params` (optional): A structure containing any [request parameters](#) that are allowed by the delete index template API.

Examples

With the following snippet we will delete all index templates that are declared in the `templates` section but only if they existed previously (implicit default):

```
{
  "name": "delete-all-index-templates",
  "operation-type": "delete-index-template"
}
```

With the following snippet we will delete the *default* index template:

```
{
  "name": "delete-default-template",
  "operation-type": "delete-index-template",
  "template": "default",
  "only-if-exists": false,
  "delete-matching-indices": true,
  "index-pattern": "*"
}
```

: If `delete-matching-indices` is set to `true`, indices with the provided `index-pattern` are deleted regardless whether the index template has previously existed.

This is an administrative operation. Metrics are not reported by default. Reporting can be forced by setting `include-in-reporting` to `true`.

challenge

If your track has only one challenge, you can use the `challenge` element. If you have multiple challenges, you can define an array of `challenges`.

This section contains one or more challenges which describe the benchmark scenarios for this data set. A challenge can reference all operations that are defined in the `operations` section.

Each challenge consists of the following properties:

- `name` (mandatory): A descriptive name of the challenge. Should not contain spaces in order to simplify handling on the command line for users.
- `description` (optional): A human readable description of the challenge.
- `default` (optional): If `true`, Rally selects this challenge by default if the user did not specify a challenge on the command line. If your track only defines one challenge, it is implicitly selected as default, otherwise you need define `"default": true` on exactly one challenge.
- `index-settings` (optional): Defines the index settings of the benchmark candidate when an index is created. Note that these settings are only applied if the index is auto-managed.
- `schedule` (mandatory): Defines the concrete execution order of operations. It is described in more detail below.

: You should strive to minimize the number of challenges. If you just want to run a subset of the tasks in a challenge, use *task filtering*.

schedule

The `schedule` element contains a list of tasks that are executed by Rally. Each task consists of the following properties:

- `name` (optional): This property defines an explicit name for the given task. By default the operation's name is implicitly used as the task name but if the same operation is run multiple times, a unique task name must be specified using this property.
- `operation` (mandatory): This property refers either to the name of an operation that has been defined in the `operations` section or directly defines an operation inline.
- `clients` (optional, defaults to 1): The number of clients that should execute a task concurrently.
- `warmup-iterations` (optional, defaults to 0): Number of iterations that each client should execute to warmup the benchmark candidate. Warmup iterations will not show up in the measurement results.
- `iterations` (optional, defaults to 1): Number of measurement iterations that each client executes. The command line report will automatically adjust the percentile numbers based on this number (i.e. if you just run 5 iterations you will not get a 99.9th percentile because we need at least 1000 iterations to determine this value precisely).
- `warmup-time-period` (optional, defaults to 0): A time period in seconds that Rally considers for warmup of the benchmark candidate. All response data captured during warmup will not show up in the measurement results.
- `time-period` (optional): A time period in seconds that Rally considers for measurement. Note that for bulk indexing you should usually not define this time period. Rally will just bulk index all documents and consider every sample after the warmup time period as measurement sample.
- `schedule` (optional, defaults to `deterministic`): Defines the schedule for this task, i.e. it defines at which point in time during the benchmark an operation should be executed. For example, if you specify a `deterministic` schedule and a `target-interval` of 5 (seconds), Rally will attempt to execute the corresponding operation at second 0, 5, 10, 15 Out of the box, Rally supports `deterministic` and `poisson` but you can define your own *custom schedules*.
- `target-throughput` (optional): Defines the benchmark mode. If it is not defined, Rally assumes this is a throughput benchmark and will run the task as fast as it can. This is mostly needed for batch-style operations where it is more important to achieve the best throughput instead of an acceptable latency. If it is defined, it specifies the number of requests per second over all clients. E.g. if you specify `target-throughput: 1000` with 8 clients, it means that each client will issue 125 (= 1000 / 8) requests per second. In total, all clients will issue 1000 requests each second. If Rally reports less than the specified throughput then Elasticsearch simply cannot reach it.
- `target-interval` (optional): This is just $1 / \text{target-throughput}$ (in seconds) and may be more convenient for cases where the throughput is less than one operation per second. Define either `target-throughput` or `target-interval` but not both (otherwise Rally will raise an error).

Defining operations

In the following snippet we define two operations `force-merge` and a `match-all` query separately in an `operations` block:

```
{
  "operations": [
    {
      "name": "force-merge",
      "operation-type": "force-merge"
    },
    {
      "name": "match-all-query",
      "operation-type": "search",
      "body": {
        "query": {
          "match_all": {}
        }
      }
    }
  ],
  "challenge": {
    "name": "just-query",
    "schedule": [
      {
        "operation": "force-merge",
        "clients": 1
      },
      {
        "operation": "match-all-query",
        "clients": 4,
        "warmup-iterations": 1000,
        "iterations": 1000,
        "target-throughput": 100
      }
    ]
  }
}
```

If we do not want to reuse these operations, we can also define them inline. Note that the operations section is gone:

```
{
  "challenge": {
    "name": "just-query",
    "schedule": [
      {
        "operation": {
          "name": "force-merge",
          "operation-type": "force-merge"
        },
        "clients": 1
      },
      {
        "operation": {
          "name": "match-all-query",
          "operation-type": "search",
          "body": {
            "query": {
              "match_all": {}
            }
          }
        }
      }
    ],
  },
}
```

```

    "clients": 4,
    "warmup-iterations": 1000,
    "iterations": 1000,
    "target-throughput": 100
  }
]
}

```

Contrary to the query, the `force-merge` operation does not take any parameters, so Rally allows us to just specify the `operation-type` for this operation. Its name will be the same as the operation's type:

```

{
  "challenge": {
    "name": "just-query",
    "schedule": [
      {
        "operation": "force-merge",
        "clients": 1
      },
      {
        "operation": {
          "name": "match-all-query",
          "operation-type": "search",
          "body": {
            "query": {
              "match_all": {}
            }
          }
        }
      },
      {
        "clients": 4,
        "warmup-iterations": 1000,
        "iterations": 1000,
        "target-throughput": 100
      }
    ]
  }
}

```

Choosing a schedule

Rally allows you to choose between the following schedules to simulate traffic:

- deterministically distributed
- Poisson distributed

The diagram below shows how different schedules in Rally behave during the first ten seconds of a benchmark. Each schedule is configured for a (mean) target throughput of one operation per second.

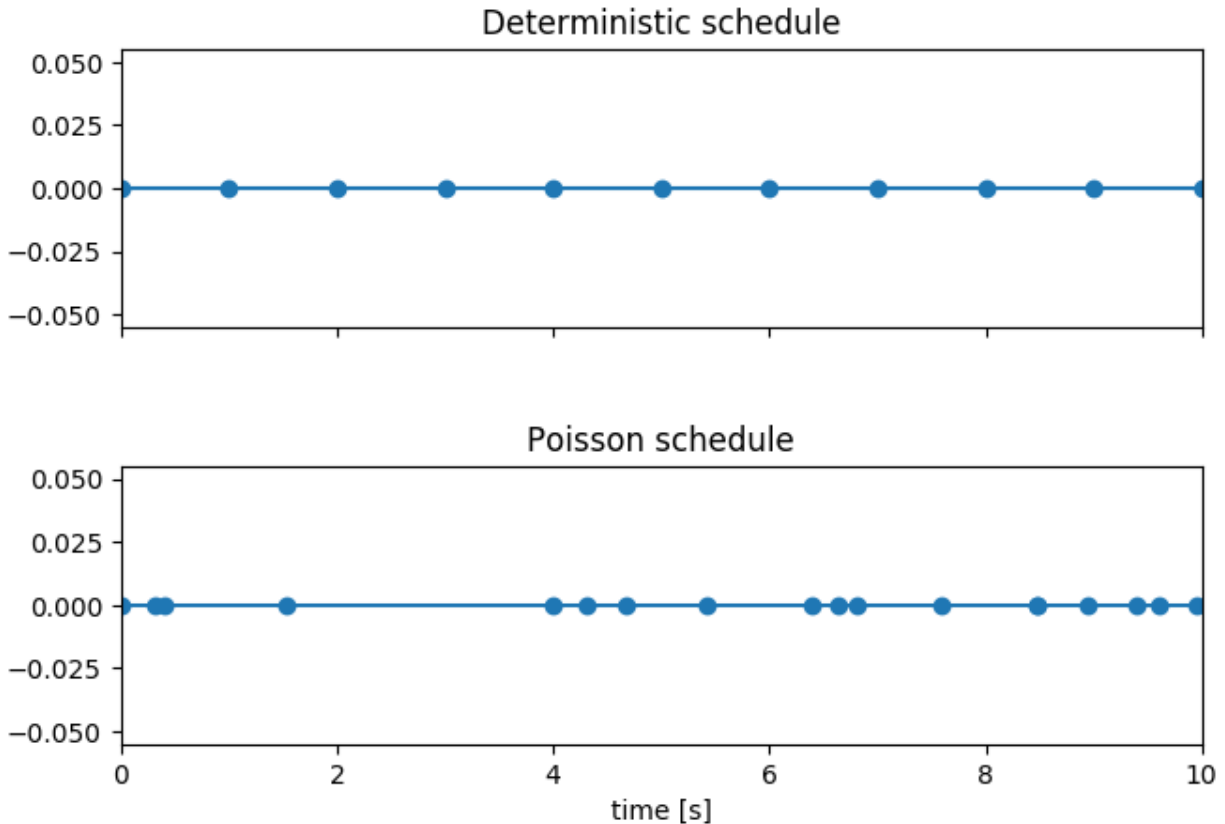

If you want as much reproducibility as possible you can choose the *deterministic* schedule. A Poisson distribution models random independent arrivals of clients which on average match the expected arrival rate which makes it suitable for modelling the behaviour of multiple clients that decide independently when to issue a request. For this reason, Poisson processes play an important role in [queueing theory](#).

If you have more complex needs on how to model traffic, you can also implement a *custom schedule*.

Time-based vs. iteration-based

You should usually use time periods for batch style operations and iterations for the rest. However, you can also choose to run a query for a certain time period.

All tasks in the `schedule` list are executed sequentially in the order in which they have been defined. However, it is also possible to execute multiple tasks concurrently, by wrapping them in a `parallel` element. The `parallel` element defines of the following properties:

- `clients` (optional): The number of clients that should execute the provided tasks. If you specify this property, Rally will only use as many clients as you have defined on the `parallel` element (see examples)!
- `warmup-time-period` (optional, defaults to 0): Allows to define a default value for all tasks of the `parallel` element.
- `time-period` (optional, no default value if not specified): Allows to define a default value for all tasks of the `parallel` element.
- `warmup-iterations` (optional, defaults to 0): Allows to define a default value for all tasks of the `parallel` element.
- `iterations` (optional, defaults to 1): Allows to define a default value for all tasks of the `parallel` element.

- `completed-by` (optional): Allows to define the name of one task in the `tasks` list. As soon as this task has completed, the whole `parallel` task structure is considered completed. If this property is not explicitly defined, the `parallel` task structure is considered completed as soon as all its subtasks have completed. A task is completed if and only if all associated clients have completed execution.
- `tasks` (mandatory): Defines a list of tasks that should be executed concurrently. Each task in the list can define the following properties that have been defined above: `clients`, `warmup-time-period`, `time-period`, `warmup-iterations` and `iterations`.

: `parallel` elements cannot be nested.

: Specify the number of clients on each task separately. If you specify this number on the `parallel` element instead, Rally will only use that many clients in total and you will only want to use this behavior in very rare cases (see examples)!

4.11.5 Examples

A track with a single task

To get started with custom tracks, you can benchmark a single task, e.g. a `match_all` query:

```
{
  "challenge": {
    "name": "just-search",
    "schedule": [
      {
        "operation": {
          "operation-type": "search",
          "index": "_all",
          "body": {
            "query": {
              "match_all": {}
            }
          }
        }
      },
      {
        "warmup-iterations": 100,
        "iterations": 100,
        "target-throughput": 10
      }
    ]
  }
}
```

This track assumes that you have an existing cluster with pre-populated data. It will run the provided `match_all` query at 10 operations per second with one client and use 100 iterations as warmup and the next 100 iterations to measure.

For the examples below, note that we do not show the operation definition but you should be able to infer from the operation name what it is doing.

Running unthrottled

In this example Rally will run a bulk index operation unthrottled for one hour:

```
"schedule": [
  {
    "operation": "bulk",
    "warmup-time-period": 120,
    "time-period": 3600,
    "clients": 8
  }
]
```

Running tasks in parallel

: You cannot nest parallel tasks.

If we want to run tasks in parallel, we can use the `parallel` element. In the simplest case, you let Rally decide the number of clients needed to run the parallel tasks (note how we can define default values on the `parallel` element):

```
{
  "parallel": {
    "warmup-iterations": 50,
    "iterations": 100,
    "tasks": [
      {
        "operation": "default",
        "target-throughput": 50
      },
      {
        "operation": "term",
        "target-throughput": 200
      },
      {
        "operation": "phrase",
        "target-throughput": 200
      }
    ]
  }
}
```

Rally will determine that three clients are needed to run each task in a dedicated client. You can also see that each task can have different settings.

However, you can also explicitly define the number of clients:

```
"schedule": [
  {
    "parallel": {
      "warmup-iterations": 50,
      "iterations": 100,
      "tasks": [
        {
          "operation": "match-all",
          "clients": 4,
          "target-throughput": 50
        },
      ],
    }
  }
]
```

```

    {
      "operation": "term",
      "clients": 2,
      "target-throughput": 200
    },
    {
      "operation": "phrase",
      "clients": 2,
      "target-throughput": 200
    }
  ]
}
]

```

This schedule will run a match all query, a term query and a phrase query concurrently. It will run with eight clients in total (four for the match all query and two each for the term and phrase query).

In this scenario, we run indexing and a few queries in parallel with a total of 14 clients:

```

"schedule": [
  {
    "parallel": {
      "tasks": [
        {
          "operation": "bulk",
          "warmup-time-period": 120,
          "time-period": 3600,
          "clients": 8,
          "target-throughput": 50
        },
        {
          "operation": "default",
          "clients": 2,
          "warmup-iterations": 50,
          "iterations": 100,
          "target-throughput": 50
        },
        {
          "operation": "term",
          "clients": 2,
          "warmup-iterations": 50,
          "iterations": 100,
          "target-throughput": 200
        },
        {
          "operation": "phrase",
          "clients": 2,
          "warmup-iterations": 50,
          "iterations": 100,
          "target-throughput": 200
        }
      ]
    }
  }
]

```

We can use `completed-by` to stop querying as soon as bulk-indexing has completed:

```
"schedule": [
  {
    "parallel": {
      "completed-by": "bulk",
      "tasks": [
        {
          "operation": "bulk",
          "warmup-time-period": 120,
          "time-period": 3600,
          "clients": 8,
          "target-throughput": 50
        },
        {
          "operation": "default",
          "clients": 2,
          "warmup-time-period": 480,
          "time-period": 7200,
          "target-throughput": 50
        }
      ]
    }
  }
]
```

We can also mix sequential tasks with the `parallel` element. In this scenario we are indexing with 8 clients and continue querying with 6 clients after indexing has finished:

```
"schedule": [
  {
    "operation": "bulk",
    "warmup-time-period": 120,
    "time-period": 3600,
    "clients": 8,
    "target-throughput": 50
  },
  {
    "parallel": {
      "warmup-iterations": 50,
      "iterations": 100,
      "tasks": [
        {
          "operation": "default",
          "clients": 2,
          "target-throughput": 50
        },
        {
          "operation": "term",
          "clients": 2,
          "target-throughput": 200
        },
        {
          "operation": "phrase",
          "clients": 2,
          "target-throughput": 200
        }
      ]
    }
  }
]
```

```
]
```

Be aware of the following case where we explicitly define that we want to run only with two clients *in total*:

```
"schedule": [
  {
    "parallel": {
      "warmup-iterations": 50,
      "iterations": 100,
      "clients": 2,
      "tasks": [
        {
          "operation": "match-all",
          "target-throughput": 50
        },
        {
          "operation": "term",
          "target-throughput": 200
        },
        {
          "operation": "phrase",
          "target-throughput": 200
        }
      ]
    }
  }
]
```

Rally will *not* run all three tasks in parallel because you specified that you want only two clients in total. Hence, Rally will first run “match-all” and “term” concurrently (with one client each). After they have finished, Rally will run “phrase” with one client. You could also specify more clients than there are tasks but these will then just idle.

You can also specify a number of clients on sub tasks explicitly (by default, one client is assumed per subtask). This allows to define a weight for each client operation. Note that you need to define the number of clients also on the `parallel` parent element, otherwise Rally would determine the number of totally needed clients again on its own:

```
{
  "parallel": {
    "clients": 3,
    "warmup-iterations": 50,
    "iterations": 100,
    "tasks": [
      {
        "operation": "default",
        "target-throughput": 50
      },
      {
        "operation": "term",
        "target-throughput": 200
      },
      {
        "operation": "phrase",
        "target-throughput": 200,
        "clients": 2
      }
    ]
  }
}
```



```

├── log4j2.properties
├── verbose_iw
│   └── config
│       ├── elasticsearch.yml
│       ├── jvm.options
│       └── log4j2.properties
└── verbose_iw.ini

```

Each `.ini` file in the top level directory defines a car. And each directory (`ea`, `vanilla` or `verbose_iw`) contains templates for the config files.

Let's have a look at the `1gheap` car by inspecting `1gheap.ini`:

```

[meta]
description=Sets the Java heap to 1GB
type=car

[config]
base=vanilla

[variables]
heap_size=1g

```

The name of the car is derived from the `ini` file name. In the `meta` section we can provide a `description` and the `type`. Use `car` if a configuration can be used standalone and `mixin` if it needs to be combined with other configurations. In the `config` section we define that this definition is based on the `vanilla` configuration. We also define a variable `heap_size` and set it to `1g`.

Let's open `vanilla/config/jvm.options` to see how this variable is used (we'll only show the relevant part here):

```

# Xms represents the initial size of total heap space
# Xmx represents the maximum size of total heap space

-Xms{{heap_size}}
-Xmx{{heap_size}}

```

So Rally reads all variables and the template files and replaces the variables in the final configuration. Note that Rally does not know anything about `jvm.options` or `elasticsearch.yml`. For Rally, these are just plain text templates that need to be copied to the `Elasticsearch` directory before running a benchmark. Under the hood, Rally uses `Jinja2` as template language. This allows you to use `Jinja2` expressions in your car configuration files.

If you open `vanilla/config/elasticsearch.yml` you will see a few variables that are not defined in the `.ini` file:

- `network_host`
- `http_port`
- `node_count_per_host`

These values are derived by Rally internally based on command line flags and you cannot override them in your car definition. You also cannot use these names as names for variables because Rally would simply override them.

If you specify multiple configurations, e.g. `--car="4gheap,ea"`, Rally will apply them in order. It will first read all variables in `4gheap.ini`, then in `ea.ini`. Afterwards, it will copy all configuration files from the corresponding config base of `4gheap` and `append` all configuration files from `ea`. This also shows when to define a separate "car" and when to define a "mixin": If you need to amend configuration files, use a `mixin`, if you need to have a specific configuration, define a car.

Custom Team Repositories

Rally provides a default team repository that is hosted on [Github](#). You can also add your own team repositories although this requires a bit of additional work. First of all, team repositories need to be managed by git. The reason is that Rally can benchmark multiple versions of Elasticsearch and we use git branches in the track repository to determine the best match. The versioning scheme is as follows:

- The *master* branch needs to work with the latest *master* branch of Elasticsearch.
- All other branches need to match the version scheme of Elasticsearch, i.e. MAJOR.MINOR.PATCH-SUFFIX where all parts except MAJOR are optional.

Rally implements a fallback logic so you don't need to define a branch for each patch release of Elasticsearch. For example:

- The branch *6.0.0-alpha1* will be chosen for the version *6.0.0-alpha1* of Elasticsearch.
- The branch *5* will be chosen for all versions for Elasticsearch with the major version 5, e.g. *5.0.0*, *5.1.3* (provided there is no specific branch).

Rally tries to use the branch with the best match to the benchmarked version of Elasticsearch.

Creating a new team repository

All team repositories are located in `~/.rally/benchmarks/teams`. If you want to add a dedicated team repository, called `private` follow these steps:

```
cd ~/.rally/benchmarks/teams
mkdir private
cd private
git init
# add your team now (don't forget to add the subdirectory "cars").
git add .
git commit -m "Initial commit"
```

If you want to share your teams with others (or you want to run remote benchmarks) you need to add a remote and push it:

```
git remote add origin git@git-repos.acme.com:acme/rally-teams.git
git push -u origin master
```

If you have added a remote you should also add it in `~/.rally/rally.ini`, otherwise you can skip this step. Open the file in your editor of choice and add the following line in the section `teams`:

```
private.url = <<URL_TO_YOUR_ORIGIN>>
```

Rally will then automatically update the local tracking branches before the benchmark starts.

: If you run benchmarks against a remote machine that is under the control of Rally then you need to add the custom team configuration on every node!

You can now verify that everything works by listing all teams in this team repository:

```
esrally list cars --team-repository=private
```

This shows all teams that are available on the `master` branch of this repository. Suppose you only created tracks on the branch `2` because you're interested in the performance of Elasticsearch 2.x, then you can specify also the distribution version:

```
esrally list teams --team-repository=private --distribution-version=2.0.0
```

Rally will follow the same branch fallback logic as described above.

Adding an already existing team repository

If you want to add a team repository that already exists, just open `~/.rally/rally.ini` in your editor of choice and add the following line in the section `teams`:

```
your_repo_name.url = <<URL_TO_YOUR_ORIGIN>>
```

After you have added this line, have Rally list the tracks in this repository:

```
esrally list cars --team-repository=your_repo_name
```

4.13 Using Elasticsearch Plugins

You can have Rally setup an Elasticsearch cluster with plugins for you. However, there are a couple of restrictions:

- This feature is only supported from Elasticsearch 5.0.0 onwards
- Whereas Rally caches downloaded Elasticsearch distributions, plugins will always be installed via the Internet and thus each machine where an Elasticsearch node will be installed, requires an active Internet connection.

4.13.1 Listing plugins

To see which plugins are available, run `esrally list elasticsearch-plugins`:

```
Available Elasticsearch plugins:
```

Name	Configuration
-----	-----
analysis-icu	
analysis-kuromoji	
analysis-phonetic	
analysis-smartcn	
analysis-stempel	
analysis-ukrainian	
discovery-azure-classic	
discovery-ec2	
discovery-file	
discovery-gce	
ingest-attachment	
ingest-geoip	
ingest-user-agent	
lang-javascript	
lang-python	
mapper-attachments	
mapper-murmur3	
mapper-size	

```
repository-azure
repository-gcs
repository-hdfs
repository-s3
store-smb
x-pack           monitoring-local
x-pack           monitoring-http
x-pack           security
```

Rally supports plugins only for Elasticsearch 5.0 or better. As the availability of plugins may change from release to release we recommend that you include the `--distribution-version` parameter when listing plugins. By default Rally assumes that you want to benchmark the latest master version of Elasticsearch.

Let's see what happens if we run `esrally list elasticsearch-plugins --distribution-version=2.4.0`:

```
No Elasticsearch plugins are available.
```

As mentioned before, this is expected as only Elasticsearch 5.0 or better is supported.

4.13.2 Running a benchmark with plugins

In order to tell Rally to install a plugin, use the `--elasticsearch-plugins` parameter when starting a race. You can provide multiple plugins (comma-separated) and they will be installed in the order to that you define on the command line.

Example:

```
esrally --distribution-version=5.5.0 --elasticsearch-plugins="analysis-icu,analysis-  
↳phonetic"
```

This will install the plugins `analysis-icu` and `analysis-phonetic` (in that order). In order to use the features that these plugins provide, you need to write a *custom track*.

Rally will use several techniques to install and configure plugins:

- First, Rally checks whether directory `plugins/PLUGIN_NAME` in the currently configured team repository exists. If this is the case, then plugin installation and configuration details will be read from this directory.
- Next, Rally will use the provided plugin name when running the Elasticsearch plugin installer. With this approach we can avoid to create a plugin configuration directory in the team repository for very simple plugins that do not need any configuration.

As mentioned above, Rally also allows you to specify a plugin configuration and you can even combine them. Here are some examples:

- Run a benchmark with the `x-pack` plugin in the `security` configuration:
`--elasticsearch-plugins=x-pack:security`
- Run a benchmark with the `x-pack` plugin in the `security` and the `graph` configuration:
`--elasticsearch-plugins=x-pack:security+graph`

: To benchmark the `security` configuration of `x-pack` you need to add the following command line options: `--client-options="use_ssl:true,verify_certs:false,basic_auth_user:'rally',basic_auth_password:'rally-password'" --cluster-health=yellow`

You can also override plugin variables with `--plugin-params` which is needed for example if you want to use the `monitoring-http` configuration in order to export monitoring data. You can export monitoring data e.g. with the following configuration:

```
--elasticsearch-plugins="x-pack:monitoring-http" --plugin-params="monitoring_type:
↪ 'https', monitoring_host: 'some_remote_host', monitoring_port: 10200, monitoring_user:
↪ 'rally', monitoring_password: 'm0n1t0r1ng'"
```

The `monitoring_user` and `monitoring_password` parameters are optional, the other parameters are mandatory. For more details on the configuration options, please see the [Monitoring plugin documentation](#).

If you are behind a proxy, please set the environment variable `ES_JAVA_OPTS` accordingly on each target machine as described in the [Elasticsearch plugin documentation](#).

4.13.3 Building plugins from sources

Plugin authors may want to benchmark source builds of their plugins. Your plugin is either:

- built alongside Elasticsearch
- built against a released version of Elasticsearch

Plugins built alongside Elasticsearch

To make this work, you need to manually edit Rally's configuration file in `~/.rally/rally.ini`. Suppose, we want to benchmark the plugin "my-plugin". Then you need to add the following entries in the `source` section:

```
plugin.my-plugin.remote.repo.url = git@github.com:example-org/my-plugin.git
plugin.my-plugin.src.subdir = elasticsearch-extra/my-plugin
plugin.my-plugin.build.task = :my-plugin:plugin:assemble
plugin.my-plugin.build.artifact.subdir = plugin/build/distributions
```

Let's discuss these properties one by one:

- `plugin.my-plugin.remote.repo.url` (optional): This is needed to let Rally checkout the source code of the plugin. If this is a private repo, credentials need to be setup properly. If the source code is already locally available you may not need to define this property. The remote's name is assumed to be "origin" and this is not configurable. Also, only git is supported as revision control system.
- `plugin.my-plugin.src.subdir` (mandatory): This is the directory to which the plugin will be checked out relative to `src.root.dir`. In order to allow to build the plugin alongside Elasticsearch, the plugin needs to reside in a subdirectory of `elasticsearch-extra` (see also the [Elasticsearch testing documentation](#)).
- `plugin.my-plugin.build.task` (mandatory): The Gradle task to run in order to build the plugin artifact. Note that this command is run from the Elasticsearch source directory as Rally assumes that you want to build your plugin alongside Elasticsearch (otherwise, see the next section).
- `plugin.my-plugin.build.artifact.subdir` (mandatory): This is the subdirectory relative to `plugin.my-plugin.src.subdir` in which the final plugin artifact is located.

In order to run a benchmark with `my-plugin`, you'd invoke Rally as follows: `esrally --revision="elasticsearch:some-elasticsearch-revision, my-plugin:some-plugin-revision" --elasticsearch-plugins="my-plugin"` where you need to replace `some-elasticsearch-revision` and `some-plugin-revision` with the appropriate *git revisions*. Adjust other command line parameters (like `track` or `car`) accordingly. In order for this to work, you need to ensure that:

- All prerequisites for source builds are installed.

- The Elasticsearch source revision is compatible with the chosen plugin revision. Note that you do not need to know the revision hash to build against an already released version and can use git tags instead. E.g. if you want to benchmark against Elasticsearch 5.6.1, you can specify `--revision="elasticsearch:v5.6.1,my-plugin:some-plugin-revision"` (see e.g. the [Elasticsearch tags on Github](#) or use `git tag` in the Elasticsearch source directory on the console).
- If your plugin needs to be configured, please ensure to create a proper plugin specification (see below).

: Rally can build all [Elasticsearch core plugins](#) out of the box without any further configuration.

Plugins based on a released Elasticsearch version

To make this work, you need to manually edit Rally’s configuration file in `~/.rally/rally.ini`. Suppose, we want to benchmark the plugin “my-plugin”. Then you need to add the following entries in the `source` section:

```
plugin.my-plugin.remote.repo.url = git@github.com:example-org/my-plugin.git
plugin.my-plugin.src.dir = /path/to/your/plugin/sources
plugin.my-plugin.build.task = :my-plugin:plugin:assemble
plugin.my-plugin.build.artifact.subdir = build/distributions
```

Let’s discuss these properties one by one:

- `plugin.my-plugin.remote.repo.url` (optional): This is needed to let Rally checkout the source code of the plugin. If this is a private repo, credentials need to be setup properly. If the source code is already locally available you may not need to define this property. The remote’s name is assumed to be “origin” and this is not configurable. Also, only git is supported as revision control system.
- `plugin.my-plugin.src.dir` (mandatory): This is the absolute directory to which the source code will be checked out.
- `plugin.my-plugin.build.task` (mandatory): The Gradle task to run in order to build the plugin artifact. This command is run from the plugin project’s root directory.
- `plugin.my-plugin.build.artifact.subdir` (mandatory): This is the subdirectory relative to `plugin.my-plugin.src.dir` in which the final plugin artifact is located.

In order to run a benchmark with my-plugin, you’d invoke Rally as follows:

```
esrally --distribution-version="elasticsearch-version"
--revision="my-plugin:some-plugin-revision" --elasticsearch-plugins="my-plugin"
```

where you need to replace `elasticsearch-version` with the correct release (e.g. 6.0.0) and `some-plugin-revision` with the appropriate *git revisions*. Adjust other command line parameters (like track or car) accordingly. In order for this to work, you need to ensure that:

- All prerequisites for source builds are installed.
- The Elasticsearch release is compatible with the chosen plugin revision.
- If your plugin needs to be configured, please ensure to create a proper plugin specification (see below).

4.13.4 Anatomy of a plugin specification

Simple plugins

You can use Rally to benchmark community-contributed or even your own plugins. In the simplest case, the plugin does not need any custom configuration. Then you just need to add the download URL to your Rally configuration file. Consider we want to benchmark the plugin “my-plugin”:

```
[distributions]
plugin.my-plugin.release.url=https://example.org/my-plugin/releases/{{VERSION}}/my-
↳plugin-{{VERSION}}.zip
```

Then you can use `--elasticsearch-plugins=my-plugin` to run a benchmark with your plugin. Rally will also replace `{{VERSION}}` with the distribution version that you have specified on the command line.

Plugins which require configuration

If the plugin needs a custom configuration we recommend to fork the [official Rally teams repository](#) and add your plugin configuration there. Suppose, you want to benchmark “my-plugin” which has the following settings that can be configured in `elasticsearch.yml`:

- `myplugin.active`: a boolean which activates the plugin
- `myplugin.mode`: Either `simple` or `advanced`

We want to support two configurations for this plugin: `simple` which will set `myplugin.mode` to `simple` and `advanced` which will set `myplugin.mode` to `advanced`.

First, we need a template configuration. We will call this a “config base” in Rally. We will just need one config base for this example and will call it “default”.

In `$TEAM_REPO_ROOT` create the directory structure for the plugin and its config base with `mkdir -p myplugin/default/config` and add the following `elasticsearch.yml` in the new directory:

```
myplugin.active: true
myplugin.mode={{my_plugin_mode}}
```

That’s it. Later, Rally will just copy all files in `myplugin/default` to the home directory of the Elasticsearch node that it configures. First, Rally will always apply the car’s configuration and then plugins can add their configuration on top. This also explains why we have created a `config/elasticsearch.yml`. Rally will just copy this file and replace template variables on the way.

: If you create a new customization for a plugin, ensure that the plugin name in the team repository matches the core plugin name. Note that hyphens need to be replaced by underscores (e.g. “x-pack” becomes “x_pack”). The reason is that Rally allows to write custom install hooks and the plugin name will become the root package name of the install hook. However, hyphens are not supported in Python which is why we use underscores instead.

The next step is now to create our two plugin configurations where we will set the variables for our config base “default”. Create a file `simple.ini` in the `myplugin` directory:

```
[config]
# reference our one and only config base here
base=default

[variables]
my_plugin_mode=simple
```

Similarly, create `advanced.ini` in the `myplugin` directory:

```
[config]
# reference our one and only config base here
base=default
```

```
[variables]
my_plugin_mode=advanced
```

Rally will now know about `myplugin` and its two configurations. Let's check that with `esrally list elasticsearch-plugins`:

```
Available Elasticsearch plugins:

Name                               Configuration
-----
analysis-icu
analysis-kuromoji
analysis-phonetic
analysis-smartcn
analysis-stempel
analysis-ukrainian
discovery-azure-classic
discovery-ec2
discovery-file
discovery-gce
ingest-attachment
ingest-geoip
ingest-user-agent
lang-javascript
lang-python
mapper-attachments
mapper-murmur3
mapper-size
myplugin                           simple
myplugin                           advanced
repository-azure
repository-gcs
repository-hdfs
repository-s3
store-smb
x-pack                             monitoring-local
x-pack                             monitoring-http
x-pack                             security
```

As `myplugin` is not a core plugin, the Elasticsearch plugin manager does not know from where to install it, so we need to add the download URL to `~/.rally/rally.ini` as before:

```
[distributions]
plugin.myplugin.release.url=https://example.org/myplugin/releases/{{VERSION}}/
↳myplugin-{{VERSION}}.zip
```

Now you can run benchmarks with the custom Elasticsearch plugin, e.g. with `esrally --distribution-version=5.5.0 --elasticsearch-plugins="myplugin:simple"`.

For this to work you need ensure two things:

1. The plugin needs to be available for the version that you want to benchmark (5.5.0 in the example above).
2. Rally will choose the most appropriate branch in the team repository before starting the benchmark. In practice, this will most likely be branch "5" for this example. Therefore you need to ensure that your plugin configuration is also available on that branch. See the [README in the team repository](#) to learn how the versioning scheme works.

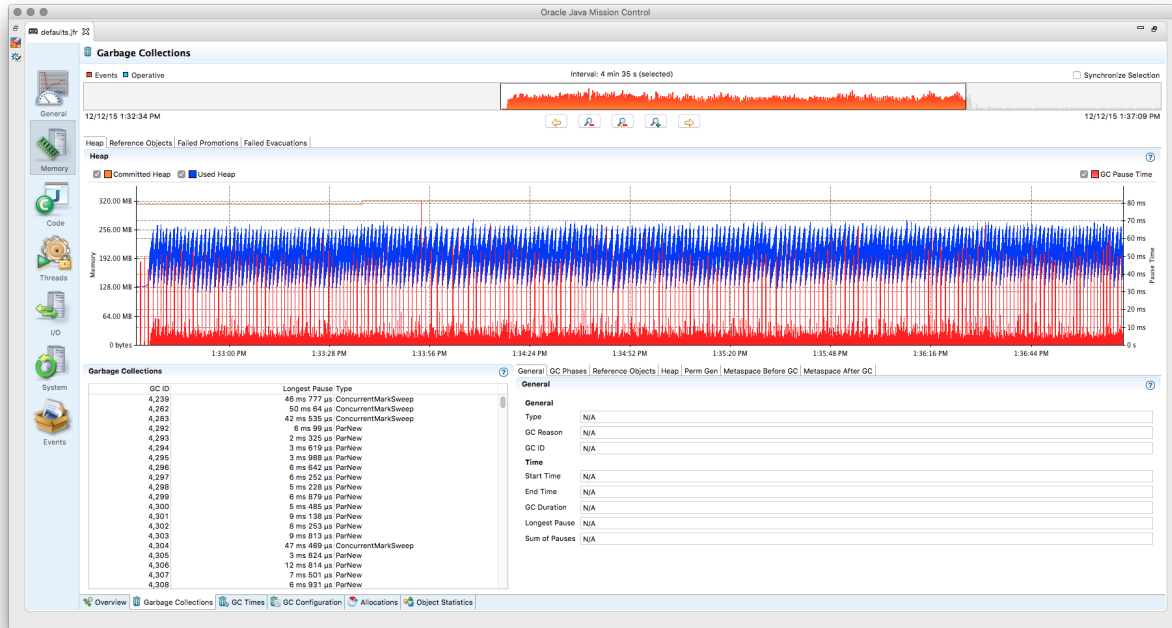

: The licensing terms of Java flight recorder do not allow you to run it in production environments without a valid license (for details, please refer to the [Oracle Java SE Advanced & Suite Products page](#)). However, running in a QA environment is fine.

4.14.2 jit

The `jit` telemetry device enables JIT compiler logs for the benchmark candidate. If the HotSpot disassembler library is available, the logs will also contain the disassembled JIT compiler output which can be used for low-level analysis. We recommend to use [JITWatch](#) for analysis.

`hsdis` can be built for JDK 8 on Linux with (based on a [description by Alex Blewitt](#)):

```
curl -O -O -O -O https://raw.githubusercontent.com/dmlloyd/openjdk/jdk8u/jdk8u/
↳ hotspot/src/share/tools/hsdis/{hsdis.c,hsdis.h,Makefile,README}
mkdir -p build/binutils
curl http://ftp.gnu.org/gnu/binutils/binutils-2.27.tar.gz | tar --strip-components=1 -
↳ C build/binutils -z -x -f -
make BINUTILS=build/binutils ARCH=amd64
```

After it has been built, the binary needs to be copied to the JDK directory (see README of `hsdis` for details).

4.14.3 gc

The `gc` telemetry device enables GC logs for the benchmark candidate. You can use tools like [GCViewer](#) to analyze the GC logs.

4.14.4 perf

The `perf` telemetry device runs `perf stat` on each benchmarked node and writes the output to a log file. It can be used to capture low-level CPU statistics. Note that the `perf` tool, which is only available on Linux, must be installed before using this telemetry device.

4.15 Rally Daemon

At its heart, Rally is a distributed system, just like Elasticsearch. However, in its simplest form you will not notice, because all components of Rally can run on a single node too. If you want Rally to *configure and start Elasticsearch nodes remotely* or *distribute the load test driver* to apply load from multiple machines, you need to use Rally daemon.

Rally daemon needs to run on every machine that should be under Rally's control. We can consider three different roles:

- **Benchmark coordinator:** This is the machine where you invoke `esrally`. It is responsible for user interaction, coordinates the whole benchmark and shows the results. Only one node can be the benchmark coordinator.
- **Load driver:** Nodes of this type will interpret and run *tracks*.
- **Provisioner:** Nodes of this type will configure an Elasticsearch cluster according to the provided *car* and *Elasticsearch plugin* configurations.

The two latter roles are not statically preassigned but rather determined by Rally based on the command line parameter `--load-driver-hosts` (for the load driver) and `--target-hosts` (for the provisioner).

4.15.1 Preparation

First, *install* and *configure* Rally on all machines that are involved in the benchmark. If you want to automate this, there is no need to use the interactive configuration routine of Rally. You can copy `~/rally/rally.ini` to the target machines adapting the paths in the file as necessary. We also recommend that you copy `~/rally/benchmarks/data` to all load driver machines before-hand. Otherwise, each load driver machine will need to download a complete copy of the benchmark data.

: Rally Daemon will listen on port 1900 and the actor system that Rally uses internally require access to arbitrary (unprivileged) ports. Please be sure to open up these ports between the Rally nodes.

4.15.2 Starting

For all this to work, Rally needs to form a cluster. This is achieved with the binary `esrallyd` (note the “d” - for daemon - at the end). You need to start the Rally daemon on all nodes: First on the coordinator node, then on all others. The order does matter, because nodes attempt to connect to the coordinator on startup.

On the benchmark coordinator, issue:

```
esrallyd start --node-ip=IP_OF_COORDINATOR_NODE --coordinator-ip=IP_OF_COORDINATOR_
↪NODE
```

On all other nodes, issue:

```
esrallyd start --node-ip=IP_OF_THIS_NODE --coordinator-ip=IP_OF_COORDINATOR_NODE
```

After that, all Rally nodes, know about each other and you can use Rally as usual. Please see the *tips and tricks* for more examples.

4.15.3 Stopping

You can leave the Rally daemon processes running in case you want to run multiple benchmarks. When you are done, you can stop the Rally daemon on each node with:

```
esrallyd stop
```

Contrary to startup, order does not matter here.

4.15.4 Status

You can query the status of the local Rally daemon with:

```
esrallyd status
```

4.16 Pipelines

A pipeline is a series of steps that are performed to get benchmark results. This is *not* intended to customize the actual benchmark but rather what happens before and after a benchmark.

An example will clarify the concept: If you want to benchmark a binary distribution of Elasticsearch, Rally has to download a distribution archive, decompress it, start Elasticsearch and then run the benchmark. However, if you want to benchmark a source build of Elasticsearch, it first has to build a distribution with Gradle. So, in both cases, different steps are involved and that's what pipelines are for.

You can get a list of all pipelines with `esrally list pipelines`:

```
Available pipelines:
Name                Description
-----
↳ from-distribution Downloads an Elasticsearch distribution, provisions it, runs a
↳ benchmark and reports results.
↳ from-sources-complete Builds and provisions Elasticsearch, runs a benchmark and
↳ reports results.
↳ benchmark-only       Assumes an already running Elasticsearch instance, runs a
↳ benchmark and reports results
↳ from-sources-skip-build Provisions Elasticsearch (skips the build), runs a benchmark
↳ and reports results.
```

4.16.1 benchmark-only

This is intended if you want to provision a cluster by yourself. Do not use this pipeline unless you are absolutely sure you need to. As Rally has not provisioned the cluster, results are not easily reproducible and it also cannot gather a lot of metrics (like CPU usage).

To benchmark a cluster, you also have to specify the hosts to connect to. An example invocation:

```
esrally --pipeline=benchmark-only --target-hosts=search-node-a.intranet.acme.com:9200,
↳search-node-b.intranet.acme.com:9200
```

4.16.2 from-distribution

This pipeline allows to benchmark an official Elasticsearch distribution which will be automatically downloaded by Rally. The earliest supported version is Elasticsearch 1.7.0. An example invocation:

```
esrally --pipeline=from-distribution --distribution-version=1.7.5
```

The version numbers have to match the name in the download URL path.

You can also benchmark Elasticsearch snapshot versions by specifying the snapshot repository:

```
esrally --pipeline=from-distribution --distribution-version=5.0.0-SNAPSHOT --
↳distribution-repository=snapshot
```

However, this feature is mainly intended for continuous integration environments and by default you should just benchmark official distributions.

: This pipeline is just mentioned for completeness but Rally will autoselect it for you. All you need to do is to define the `--distribution-version` flag.

4.16.3 from-sources-complete

You should use this pipeline when you want to build and benchmark Elasticsearch from sources. This pipeline will only work from Elasticsearch 5.0 onwards because Elasticsearch switched from Maven to Gradle and Rally only supports one build tool in the interest of maintainability.

Remember that you also need to install git and Gradle before and Rally needs to be configured for building for sources. If that's not the case you'll get an error and have to run `esrally configure` first. An example invocation:

```
esrally --pipeline=from-sources-complete --revision=latest
```

You have to specify a *revision*.

: This pipeline is just mentioned for completeness but Rally will automatically select it for you. All you need to do is to define the `--revision` flag.

4.16.4 from-sources-skip-build

This pipeline is similar to `from-sources-complete` except that it assumes you have built the binary once. It saves time if you want to run a benchmark twice for the exact same version of Elasticsearch. Obviously it doesn't make sense to provide a revision: It is always the previously built revision. An example invocation:

```
esrally --pipeline=from-sources-skip-build
```

4.17 Metrics

4.17.1 Metrics Records

At the end of a race, Rally stores all metrics records in its metrics store, which is a dedicated Elasticsearch cluster. Rally stores the metrics in the indices `rally-metrics-*`. It will create a new index for each month.

Here is a typical metrics record:

```
{
  "environment": "nightly",
  "track": "geonames",
  "track-params": {
    "shard-count": 3
  },
  "challenge": "append-no-conflicts",
  "car": "defaults",
  "sample-type": "normal",
  "trial-timestamp": "20160421T042749Z",
  "@timestamp": 1461213093093,
  "relative-time": 10507328,
  "name": "throughput",
  "value": 27385,
  "unit": "docs/s",
  "task": "index-append-no-conflicts",
  "operation": "index-append-no-conflicts",
  "operation-type": "Index",
  "lap": 1,
  "meta": {
    "cpu_physical_cores": 36,
    "cpu_logical_cores": 72,
    "cpu_model": "Intel(R) Xeon(R) CPU E5-2699 v3 @ 2.30GHz",
    "os_name": "Linux",
    "os_version": "3.19.0-21-generic",
    "host_name": "beast2",
    "node_name": "rally-node0",
    "source_revision": "a6c0a81",
    "distribution_version": "5.0.0-SNAPSHOT",
    "tag_reference": "Github ticket 1234",
  }
}
```

As you can see, we do not only store the metrics name and its value but lots of meta-information. This allows you to create different visualizations and reports in Kibana.

Below we describe each field in more detail.

environment

The environment describes the origin of a metric record. You define this value in the initial configuration of Rally. The intention is to clearly separate different benchmarking environments but still allow to store them in the same index.

track, track-params, challenge, car

This is the track, challenge and car for which the metrics record has been produced. If the user has provided track parameters with the command line parameter, `--track-params`, each of them is listed here too.

If you specify a car with mixins, it will be stored as one string separated with "+", e.g. `--car="4gheap,ea"` will be stored as `4gheap+ea` in the metrics store in order to simplify querying in Kibana. For more details, please see the *cars* documentation.

sample-type

Rally runs warmup trials but records all samples. Normally, we are just interested in "normal" samples but for a full picture we might want to look also at "warmup" samples.

trial-timestamp

A constant timestamp (always in UTC) that is determined when Rally is invoked. It is intended to group all samples of a benchmark trial.

@timestamp

The timestamp in milliseconds since epoch determined when the sample was taken.

relative-time

The relative time in microseconds since the start of the benchmark. This is useful for comparing time-series graphs over multiple trials, e.g. you might want to compare the indexing throughput over time across multiple benchmark trials. Obviously, they should always start at the same (relative) point in time and absolute timestamps are useless for that.

name, value, unit

This is the actual metric name and value with an optional unit (counter metrics don't have a unit). Depending on the nature of a metric, it is either sampled periodically by Rally, e.g. the CPU utilization or query latency or just measured once like the final size of the index.

task, operation, operation-type

`task` is the name of the task (as specified in the track file) that ran when this metric has been gathered. Most of the time, this value will be identical to the operation's name but if the same operation is ran multiple times, the task name will be unique whereas the operation may occur multiple times. It will only be set for metrics with name `latency` and `throughput`.

`operation` is the name of the operation (as specified in the track file) that ran when this metric has been gathered. It will only be set for metrics with name `latency` and `throughput`.

`operation-type` is the more abstract type of an operation. During a race, multiple queries may be issued which are different `operation`s` but they all have the same `operation-type` (Search). For some metrics, only the operation type matters, e.g. it does not make any sense to attribute the CPU usage to an individual query but instead attribute it just to the operation type.

lap

The lap number in which this metric was gathered. Laps start at 1. See the *command line reference* for more info on laps.

meta

Rally captures also some meta information for each metric record:

- CPU info: number of physical and logical cores and also the model name
- OS info: OS name and version
- Host name
- Node name: If Rally provisions the cluster, it will choose a unique name for each node.
- Source revision: We always record the git hash of the version of Elasticsearch that is benchmarked. This is even done if you benchmark an official binary release.
- Distribution version: We always record the distribution version of Elasticsearch that is benchmarked. This is even done if you benchmark a source release.
- Custom tag: You can define one custom tag with the command line flag `--user-tag`. The tag is prefixed by `tag_` in order to avoid accidental clashes with Rally internal tags.
- Operation-specific: The optional substructure `operation` contains additional information depending on the type of operation. For bulk requests, this may be the number of documents or for searches the number of hits.

Note that depending on the “level” of a metric record, certain meta information might be missing. It makes no sense to record host level meta info for a cluster wide metric record, like a query latency (as it cannot be attributed to a single node).

4.17.2 Metric Keys

Rally stores the following metrics:

- `latency`: Time period between submission of a request and receiving the complete response. It also includes wait time, i.e. the time the request spends waiting until it is ready to be serviced by Elasticsearch.
- `service_time`: Time period between start of request processing and receiving the complete response. This metric can easily be mixed up with `latency` but does not include waiting time. This is what most load testing tools refer to as “latency” (although it is incorrect).
- `throughput`: Number of operations that Elasticsearch can perform within a certain time period, usually per second. See the [track reference](#) for a definition of what is meant by one “operation” for each operation type.
- `merge_parts_total_time_*`: Different merge times as reported by Lucene. Only available if Lucene index writer trace logging is enabled.
- `merge_parts_total_docs_*`: See `merge_parts_total_time_*`
- `disk_io_write_bytes`: number of bytes that have been written to disk during the benchmark. On Linux this metric reports only the bytes that have been written by Elasticsearch, on Mac OS X it reports the number of bytes written by all processes.
- `disk_io_read_bytes`: number of bytes that have been read from disk during the benchmark. The same caveats apply on Mac OS X as for `disk_io_write_bytes`.
- `cpu_utilization_1s`: CPU usage in percent of the Elasticsearch process based on a one second sample period. The maximum value is $N * 100\%$ where N is the number of CPU cores available.
- `node_total_old_gen_gc_time`: The total runtime of the old generation garbage collector across the whole cluster as reported by the node stats API.
- `node_total_young_gen_gc_time`: The total runtime of the young generation garbage collector across the whole cluster as reported by the node stats API.

- `segments_count`: Total number of segments as reported by the indices stats API.
- `segments_memory_in_bytes`: Number of bytes used for segments as reported by the indices stats API.
- `segments_doc_values_memory_in_bytes`: Number of bytes used for doc values as reported by the indices stats API.
- `segments_stored_fields_memory_in_bytes`: Number of bytes used for stored fields as reported by the indices stats API.
- `segments_terms_memory_in_bytes`: Number of bytes used for terms as reported by the indices stats API.
- `segments_norms_memory_in_bytes`: Number of bytes used for norms as reported by the indices stats API.
- `segments_points_memory_in_bytes`: Number of bytes used for points as reported by the indices stats API.
- `merges_total_time`: Total runtime of merges as reported by the indices stats API. Note that this is not Wall clock time (i.e. if M merge threads ran for N minutes, we will report M * N minutes, not N minutes).
- `merges_total_throttled_time`: Total time within merges have been throttled as reported by the indices stats API. Note that this is not Wall clock time.
- `indexing_total_time`: Total time used for indexing as reported by the indices stats API. Note that this is not Wall clock time.
- `indexing_throttle_time`: Total time that indexing has been throttled as reported by the indices stats API. Note that this is not Wall clock time.
- `refresh_total_time`: Total time used for index refresh as reported by the indices stats API. Note that this is not Wall clock time.
- `flush_total_time`: Total time used for index flush as reported by the indices stats API. Note that this is not Wall clock time.
- `final_index_size_bytes`: Final resulting index size after the benchmark.

4.18

At the end of each *race*, Rally shows a summary report. Below we'll explain the meaning of each line including a reference to its corresponding *metrics key* which can be helpful if you want to build your own reports in Kibana. Note that not every summary report will show all lines.

4.18.1 Indexing time

- **Definition:** Total time used for indexing as reported by the indices stats API. Note that this is not Wall clock time (i.e. if M indexing threads ran for N minutes, we will report M * N minutes, not N minutes).
- **Corresponding metrics key:** `indexing_total_time`

4.18.2 Indexing throttle time

- **Definition:** Total time that indexing has been throttled as reported by the indices stats API. Note that this is not Wall clock time (i.e. if M indexing threads ran for N minutes, we will report M * N minutes, not N minutes).
- **Corresponding metrics key:** `indexing_throttle_time`

4.18.3 Merge time

- **Definition:** Total runtime of merges as reported by the indices stats API. Note that this is not Wall clock time.
- **Corresponding metrics key:** `merges_total_time`

4.18.4 Refresh time

- **Definition:** Total time used for index refresh as reported by the indices stats API. Note that this is not Wall clock time.
- **Corresponding metrics key:** `refresh_total_time`

4.18.5 Flush time

- **Definition:** Total time used for index flush as reported by the indices stats API. Note that this is not Wall clock time.
- **Corresponding metrics key:** `flush_total_time`

4.18.6 Merge throttle time

- **Definition:** Total time within merges have been throttled as reported by the indices stats API. Note that this is not Wall clock time.
- **Corresponding metrics key:** `merges_total_throttled_time`

4.18.7 Merge time (x)

Where X is one of:

- postings
- stored fields
- doc values
- norms
- vectors
- points
- **Definition:** Different merge times as reported by Lucene. Only available if Lucene index writer trace logging is enabled (use the car `verbose_iw` for that).
- **Corresponding metrics keys:** `merge_parts_total_time_*`

4.18.8 Median CPU usage

- **Definition:** Median CPU usage in percent of the Elasticsearch process during the whole race based on a one second sample period. The maximum value is $N * 100\%$ where N is the number of CPU cores available
- **Corresponding metrics key:** `cpu_utilization_1s`

4.18.9 Total Young Gen GC

- **Definition:** The total runtime of the young generation garbage collector across the whole cluster as reported by the node stats API.
- **Corresponding metrics key:** `node_total_young_gen_gc_time`

4.18.10 Total Old Gen GC

- **Definition:** The total runtime of the old generation garbage collector across the whole cluster as reported by the node stats API.
- **Corresponding metrics key:** `node_total_old_gen_gc_time`

4.18.11 Index size

- **Definition:** Final resulting index size after the benchmark.
- **Corresponding metrics key:** `final_index_size_bytes`

4.18.12 Totally written

- **Definition:** number of bytes that have been written to disk during the benchmark. On Linux this metric reports only the bytes that have been written by Elasticsearch, on Mac OS X it reports the number of bytes written by all processes.
- **Corresponding metrics key:** `disk_io_write_bytes`

4.18.13 Heap used for x

Where X is one of:

- doc values
- terms
- norms
- points
- stored fields
- **Definition:** Number of bytes used for the corresponding item as reported by the indices stats API.
- **Corresponding metrics keys:** `segments_*_in_bytes`

4.18.14 Segment count

- **Definition:** Total number of segments as reported by the indices stats API.
- **Corresponding metrics key:** `segments_count`

4.18.15 Throughput

Rally reports the minimum, median and maximum throughput for each task.

- **Definition:** Number of operations that Elasticsearch can perform within a certain time period, usually per second.
- **Corresponding metrics key:** `throughput`

4.18.16 Latency

Rally reports several percentile numbers for each task. Which percentiles are shown depends on how many requests Rally could capture (i.e. Rally will not show a 99.99th percentile if it could only capture five samples because that would be a vanity metric).

- **Definition:** Time period between submission of a request and receiving the complete response. It also includes wait time, i.e. the time the request spends waiting until it is ready to be serviced by Elasticsearch.
- **Corresponding metrics key:** `latency`

4.18.17 Service time

Rally reports several percentile numbers for each task. Which percentiles are shown depends on how many requests Rally could capture (i.e. Rally will not show a 99.99th percentile if it could only capture five samples because that would be a vanity metric).

- **Definition:** Time period between start of request processing and receiving the complete response. This metric can easily be mixed up with `latency` but does not include waiting time. This is what most load testing tools refer to as “latency” (although it is incorrect).
- **Corresponding metrics key:** `service_time`

4.18.18 Error rate

- **Definition:** The ratio of erroneous responses relative to the total number of responses. Any exception thrown by the Python Elasticsearch client is considered erroneous (e.g. HTTP response codes 4xx, 5xx or network errors (network unreachable)). For specific details, please check the [reference documentation of the Elasticsearch client](#). Usually any error rate greater than zero is alerting. You should investigate the root cause by inspecting Rally and Elasticsearch logs and rerun the benchmark.
- **Corresponding metrics key:** `service_time`. Each `service_time` record has a `meta.success` flag. Rally simply counts how often this flag is `true` and `false` respectively.

4.19 Migration Guide

4.19.1 Migrating to Rally 0.9.0

Track Syntax

With Rally 0.9.0, we have changed the track file format. While the previous format is still supported with deprecation warnings, we recommend that you adapt your tracks as we will remove the deprecated syntax with the next minor release.

Below is an example of a track with the previous syntax:

```
{
  "description": "Tutorial benchmark for Rally",
  "data-url": "http://benchmarks.elasticsearch.org.s3.amazonaws.com/corpora/geonames",
  "indices": [
    {
      "name": "geonames",
      "types": [
        {
          "name": "type",
          "mapping": "mappings.json",
          "documents": "documents.json",
          "document-count": 8647880,
          "uncompressed-bytes": 2790927196
        }
      ]
    }
  ],
  "challenge": {
    "name": "index-only",
    "index-settings": {
      "index.number_of_replicas": 0
    },
    "schedule": [
      {
        "operation": {
          "operation-type": "bulk",
          "bulk-size": 5000
        },
        "warmup-time-period": 120,
        "clients": 8
      }
    ]
  }
}
```

Before Rally 0.9.0, indices have been created implicitly. We will remove this ability and thus you need to tell Rally explicitly that you want to create indices. With Rally 0.9.0 your track should look as follows:

```
{
  "description": "Tutorial benchmark for Rally",
  "indices": [
    {
      "name": "geonames",
      "body": "index.json",
      "auto-managed": false,
      "types": [ "type" ]
    }
  ],
  "corpora": [
    {
      "name": "geonames",
      "documents": [
        {
          "base-url": "http://benchmarks.elasticsearch.org.s3.amazonaws.com/corpora/
↪geonames",
          "source-file": "documents.json",
          "document-count": 8647880,
```

```

        "uncompressed-bytes": 2790927196
      }
    ]
  },
  "challenge": {
    "name": "index-only",
    "schedule": [
      {
        "operation": "delete-index"
      },
      {
        "operation": {
          "operation-type": "create-index",
          "settings": {
            "index.number_of_replicas": 0
          }
        }
      },
      {
        "operation": {
          "operation-type": "cluster-health",
          "request-params": {
            "wait_for_status": "green"
          }
        }
      },
      {
        "operation": {
          "operation-type": "bulk",
          "bulk-size": 5000
        },
        "warmup-time-period": 120,
        "clients": 8
      }
    ]
  }
}

```

Let's go through the necessary changes one by one.

Define the document corpus separately

Previously you had to define the document corpus together with the document type. In order to allow you to reuse existing document corpora across tracks, you now need to specify any document corpora separately:

```

"corpora": [
  {
    "name": "geonames",
    "documents": [
      {
        "base-url": "http://benchmarks.elasticsearch.org.s3.amazonaws.com/corpora/
↪geonames",
        "source-file": "documents.json",
        "document-count": 8647880,
        "uncompressed-bytes": 2790927196
      }
    ]
  }
]

```

```

    }
  ]
}
]

```

Note that this is just a simple example that should cover the most basic case. Be sure to check the [track reference](#) for all details.

Change the index definition

The new index definition now looks as follows:

```

{
  "name": "geonames",
  "body": "index.json",
  "auto-managed": false,
  "types": [ "type" ]
}

```

We have added a `body` property to the index and removed the `mapping` property from the type. In fact, the only information that we need about the document type is its name, hence it is now a simple list of strings. Just put all type mappings now into the `mappings` property of the index definition. For more details, please refer to the [create index API documentation](#).

Secondly, we have disabled index auto-management by setting `auto-managed` to `false`. This allows us to define explicit tasks below to manage our index. Note that index auto-management is still working in Rally 0.9.0 but it will be removed with the next minor release Rally 0.10.0.

Explicitly delete and recreate the index

We have also added three tasks at the beginning of the schedule:

```

{
  "operation": "delete-index"
},
{
  "operation": {
    "operation-type": "create-index",
    "settings": {
      "index.number_of_replicas": 0
    }
  }
},
{
  "operation": {
    "operation-type": "cluster-health",
    "request-params": {
      "wait_for_status": "green"
    }
  }
}
}

```

These tasks represent what Rally previously did implicitly.

The first task will delete all indices that have been declared in the `indices` section if they existed previously. This ensures that we don't have any leftovers from previous benchmarks.

After that we will create all indices that have been declared in the `indices` section. Note that we have also removed the special property `index-settings` and moved it to the `settings` parameter of `create-index`. Rally will merge any settings from the index body definition with these settings. This means you should define settings that are always the same in the index body and settings that change from challenge to challenge in the `settings` property.

Finally, Rally will check that the cluster health is green. If you want to be able to override the cluster health check parameters from the command line, you can leverage Rally's track parameter feature:

```
{
  "operation": {
    "operation-type": "cluster-health",
    "request-params": {
      "wait_for_status": "{{ cluster_health|default('green') }}"
    }
  }
}
```

If you don't specify anything on the command line, Rally will use the default value but you can e.g. specify `--track-params="cluster_health:'yellow'"` so Rally will check for (at least) a yellow cluster health status.

Note that you can customize these operations. Please see the [track reference](#) for all details.

Custom Parameter Sources

With Rally 0.9.0, the API for custom parameter sources has changed. Previously, the following syntax was valid:

```
# for parameter sources implemented as functions
def custom_param_source(indices, params):

# for parameter sources implemented as classes
class CustomParamSource:
    def __init__(self, indices, params):
```

With Rally 0.9.0, the signatures need to be changed to:

```
# for parameter sources implemented as functions
def custom_param_source(track, params, **kwargs):

# for parameter sources implemented as classes
class CustomParamSource:
    def __init__(self, track, params, **kwargs):
```

Rally will issue a warning along the lines of `Parameter source 'custom_param_source' is using deprecated method signature if your track is affected. If you need access to the indices list, you can call track.indices to retrieve it from the track.`

4.20 Frequently Asked Questions (FAQ)

4.20.1 A benchmark aborts with `Couldn't find a tar.gz distribution.` What's the problem?

This error occurs when Rally cannot build an Elasticsearch distribution from source code. The most likely cause is that there is some problem in the build setup.

To see what's the problem, try building Elasticsearch yourself. First, find out where the source code is located (run `grep src ~/.rally/rally.ini`). Then change to the directory (`src.root.dir + elasticsearch.src.subdir` which is usually `~/.rally/benchmarks/src/elasticsearch`) and run the following commands:

```
gradle clean
gradle :distribution:tar:assemble
```

By that you are mimicking what Rally does. Fix any errors that show up here and then retry.

4.20.2 Where does Rally get the benchmark data from?

Rally comes with a set of tracks out of the box which we maintain in the [rally-tracks repository on Github](#). This repository contains the track descriptions. The actual data are stored as compressed files in an S3 bucket.

4.20.3 Will Rally destroy my existing indices?

First of all: Please (please, please) do NOT run Rally against your production cluster if you are just getting started with it. You have been warned.

Depending on the track, Rally will delete and create one or more indices. For example, the [geonames track](#) specifies that Rally should create an index named “geonames” and Rally will assume it can do to this index whatever it wants. Specifically, Rally will check at the beginning of a race if the index “geonames” exists and delete it. After that it creates a new empty “geonames” index and runs the benchmark. So if you benchmark against your own cluster (by specifying the `benchmark-only pipeline`) and this cluster contains an index that is called “geonames” you will lose (all) data if you run Rally against it. Rally will neither read nor write (or delete) any other index. So if you apply the usual care nothing bad can happen.

4.20.4 What does *latency* and *service_time* mean and how do they related to the *took* field that Elasticsearch returns?

Let's start with the *took* field of Elasticsearch. *took* is the time needed by Elasticsearch to process a request. As it is determined on the server, it can neither include the time it took the client to send the data to Elasticsearch nor the time it took Elasticsearch to send it to the client. This time is captured by *service_time*, i.e. it is the time period from the start of a request (on the client) until it has received the response.

The explanation of *latency* is a bit more involved. First of all, Rally defines two benchmarking modes:

- Throughput benchmarking mode: In this mode, Rally will issue requests as fast as it can, i.e. as soon as it receives a response, it will issue the next request. This is ideal for benchmarking indexing. In this mode `latency == service_time`.
- Throughput-throttled mode: If you define a specific target throughput rate in a track, for example 100 requests per second (you should choose this number based on the traffic pattern that you experience in your production environment), then Rally will define a schedule internally and will issue requests according to this schedule

regardless how fast Elasticsearch can respond. To put it differently: Imagine you want to grab a coffee on your way to work. You make this decision independently of all the other people going to the coffee shop so it is possible that you need to wait before you can tell the barista which coffee you want. The time it takes the barista to make your coffee is the service time. The service time is independent of the number of customers in the coffee shop. However, you as a customer also care about the length of the waiting line which depends on the number of customers in the coffee shop. The time it takes between you entering the coffee shop and taking your first sip of coffee is latency.

If you are interested in latency measurement, we recommend you watch the following talks:

“How NOT to Measure Latency” by Gil Tene:

Benchmarking Elasticsearch with Rally by Daniel Mitterdorfer:

4.20.5 Where and how long does Rally keep its data?

Rally stores a lot of data (this is just the nature of a benchmark) so you should keep an eye on disk usage. All data are kept in `~/.rally` and Rally does not implicitly delete them. These are the most important directories:

- `~/.rally/logs`: Contains all log files. Logs are rotated daily. If you don't need the logs anymore, you can safely wipe this directory.
- `~/.rally/benchmarks/races`: telemetry data, Elasticsearch logs and even complete Elasticsearch installations including the data directory if a benchmark failed. If you don't need the data anymore, you can safely wipe this directory.
- `~/.rally/benchmarks/src`: the Elasticsearch Github repository (only if you had Rally build Elasticsearch from sources at least once).
- `~/.rally/benchmarks/data`: the benchmark data sets. This directory can get very huge (way more than 100 GB if you want to try all default tracks). You can delete the files in this directory but keep in mind that Rally may need to download them again.
- `~/.rally/benchmarks/distributions`: Contains all downloaded Elasticsearch distributions.

There are a few more directories but the ones above are the most disk-hogging ones.

4.20.6 Does Rally spy on me?

No. Rally does not collect or send any usage data and also the complete source code is open. We do value your feedback a lot though and if you got any ideas for improvements, found a bug or have any other feedback, please head over to [Rally's Discuss forum](#) or [raise an issue on Github](#).

4.20.7 Do I need an Internet connection?

You do NOT need Internet access on any node of your Elasticsearch cluster but the machine where you start Rally needs an Internet connection to download track data sets and Elasticsearch distributions. After it has downloaded all data, an Internet connection is not required anymore and you can specify `--offline`. If Rally detects no active Internet connection, it will automatically enable offline mode and warn you.

We have a dedicated documentation page for [running Rally offline](#) which should cover all necessary details.

4.21

”Rally”Elasticsearch Rally

track `""track` esrally list tracks track Rally track *track*

challenge `"" challenge 410(challenge) track esrally list tracks track (challenge)`

car `"" car Elasticsearch ()(Elasticsearch) esrally list cars (Elasticsearch)`

telemetry *Telemetry* Elasticsearch (car) CPU

race `"" race "benchmarking trial"("")Rally Elasticsearch`

tournament `"" tournament race Rally`

4.22 Community Resources

Below are a few community resources about Rally. If you find an interesting article, talk or custom tracks, please [raise an issue](#) or [open a pull request](#).

4.22.1 Talks

4.22.2 Articles

[Using Rally to benchmark Elasticsearch queries](#) by Darren Smith

CHAPTER 5

License

This software is licensed under the Apache License, version 2 (“ALv2”), quoted below.

Copyright 2015-2018 Elasticsearch <<https://www.elastic.co>>

Licensed under the Apache License, Version 2.0 (the “License”); you may not use this file except in compliance with the License. You may obtain a copy of the License at

<http://www.apache.org/licenses/LICENSE-2.0>

Unless required by applicable law or agreed to in writing, software distributed under the License is distributed on an “AS IS” BASIS, WITHOUT WARRANTIES OR CONDITIONS OF ANY KIND, either express or implied. See the License for the specific language governing permissions and limitations under the License.

C

car, [105](#)

challenge, [105](#)

R

race, [105](#)

T

telemetry, [105](#)

tournament, [105](#)

track, [105](#)